

HUMPHREY[®]

FIELD ANALYZER II USER'S GUIDE

Model 720 • 730 • 735 • 740 • 745 • 750

1

Handwritten text, possibly a signature or a list of names, located in the center of the page.

2

3

Table of Contents *(this manual contains 296 pages)*

1 Introduction/ Instrument Setup *(16 pages)*

Introduction/Instrument Setup	1-1
About Visual Fields	1-2
The Humphrey Advantage	1-5
Using This Guide	1-8
Safety Precautions	1-9
System Components	1-11
Optional Components	1-14
System Assembly	1-16

2 General Operation *(24 pages)*

General Operation	2-1
General Information	2-2
The Main Menu Screen	2-9
System Setup	2-10
Additional Setup	2-21
Help Screens	2-23

3 Setting-up Tests *(24 pages)*

Setting-up Tests	3-1
Selecting the Test Pattern and Test Eye	3-2
Entering Patient Data	3-8
Using Trial Lenses	3-19
Preparing the Patient	3-22

4 Test Parameters & Strategies *(16 pages)*

Test Parameters & Strategies	4-1
Setting Test Parameters	4-2
Test Strategies	4-4
SITA™ Testing	4-10
Blue-Yellow (SWAP) Testing	4-11
Alternate Color Testing	4-16

5 Testing

(18 pages)

Testing	5-1
Start Test Options	5-2
Monitoring and Maintaining the Patient's Eye Position	5-4
Supplemental Testing	5-7
Test In Progress	5-10
Test Complete Options	5-14
Testing: A Step-by-Step Guide	5-16

6 Test Reliability

(8 pages)

Test Reliability	6-1
Factors Affecting Reliability	6-2
Patient Compliance	6-2
Patient Fixation	6-3
Trial Lenses	6-3
Evaluating Reliability	6-4
Fixation Losses	6-4
False Positive Errors	6-4
False Negative Errors	6-6
Fluctuation Values	6-6

7 STATPAC Analysis & Printing Results

(30 pages)

STATPAC Analysis & Printing Results	7-1
Introduction to STATPAC Analysis	7-2
Threshold Test Printout Formats	7-4
SITA Printout Formats	7-21
Blue-Yellow Printout Formats	7-23
Printing Current Threshold Test Results	7-25
Screening Printout Formats	7-26
Printing Current Screening Test Results	7-27
Printing Previously Saved Test Results	7-28
Grayscale Symbols	7-30
Remote Printer Access	7-30

8 File Functions

(22 pages)

9 Database Management

(26 pages)

10 Custom Testing

(20 pages)

11 Kinetic Testing

(30 pages)

File Functions	8-1
File Functions Menu	8-2
Retrieving the File Directory	8-4
Selecting Tests from the Directory	8-6
Performing File Functions	8-11
External 5.25" Floppy Drive	8-18
Organizing Patient Files	8-22
Database Management	9-1
Introduction to Database Management	9-2
Patient Database Protection Procedures	9-3
Configuration Backup and Restore	9-8
How to Handle Database Failures	9-13
Merge Database	9-23
Cleanup Hard Disk Database	9-24
Practices with Multiple Humphrey Field Analyzers	9-25
Care and Handling of Removable Storage Media	9-25
Custom Testing	10-1
Creating Custom Tests	10-2
Deleting Custom Tests	10-15
Performing Custom Tests	10-17
Printout Format	10-19
Kinetic Testing	11-1
Performing Kinetic Tests	11-2
Viewing Kinetic Tests	11-23
Printing Kinetic Tests	11-26

12 Care & Cleaning
(14 pages)

Care & Cleaning	12-1
General Use Principles	12-2
Cleaning the HFA II	12-2
Replacing Parts	12-4
Operating the Printrex Printer	12-10
Touch Screen Calibration	12-12
Using Floppy Disks	12-13

Appendix
(34 pages)

A HFA II Product Specifications	A-1
B Warranty Statement and Notification of Copyright	B-1
C Icon Glossary	C-1
D Goldmann Conversion Tables	D-1
E Test Patterns	E-1
F Installing New HFA II Software	F-1
G How SITA Works / Acknowledgments	G-1
H Troubleshooting	H-1

Index
(6 pages)

About Visual Fields	1-2
The Humphrey Advantage	1-5
Using This Guide	1-8
Safety Precautions	1-9
System Components	1-11
Optional Components	1-14
System Assembly	1-16

You are about to use the most advanced automated perimeter available, the Humphrey® Field Analyzer II (HFA II). This introductory section covers general information about the HFA II, including a brief discussion of visual fields and a summary of important instrument features.

After reading Section 1 you will be familiar with:

- the importance of visual field testing
- general principles of perimetry
- unique features of the Humphrey Field Analyzer II
- installation and safety precautions
- connecting optional external printers.

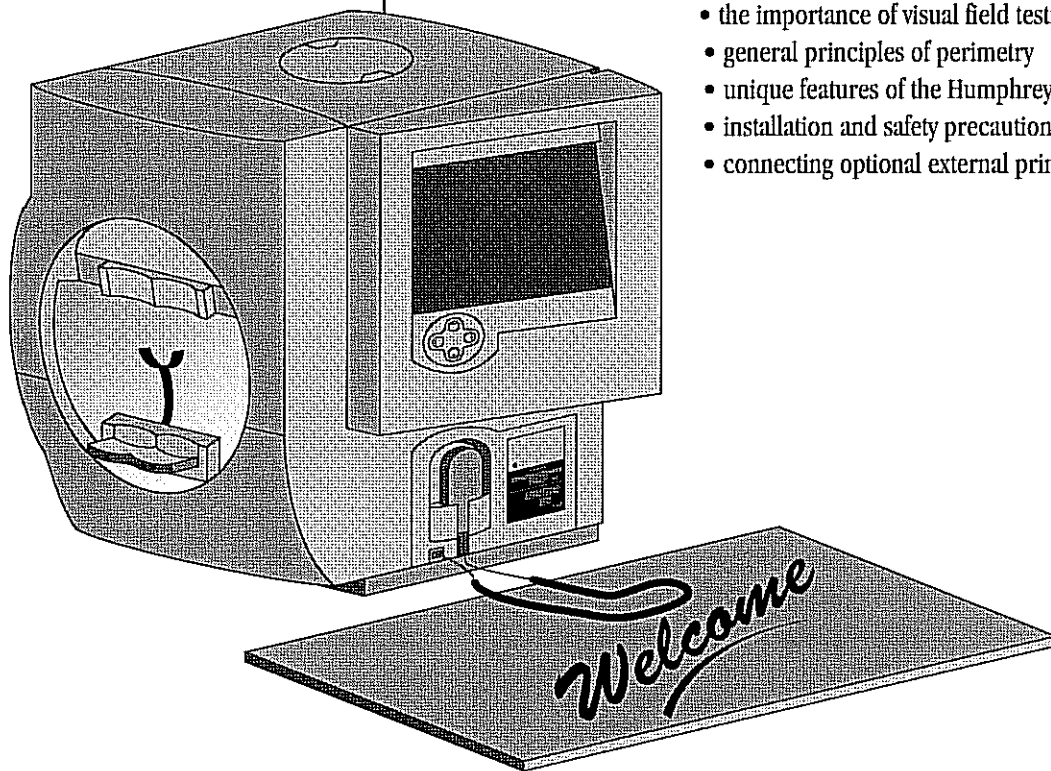

ABOUT VISUAL FIELDS

When asked to assess one's own vision, the average person often will confidently reply "I see 20/20", "20/100" or whatever the result of their visual acuity test. Fortunately, doctors appreciate the complexities involved in evaluating visual function and rely on an extensive and varied battery of diagnostic tests and instruments as part of the ocular examination. Without question, one of the most essential tools in the modern ophthalmic office is the computerized perimeter, used to evaluate the visual field.

The purpose of visual field testing, or perimetry, is to provide information critical to:

- diagnosing ocular diseases, especially glaucoma
- evaluating neurological diseases
- monitoring the progress of ocular and neurological diseases.

Visual field testing can lead to early detection and treatment of disease. In the case of glaucoma, visual fields play a major role in identifying visual field defects and evaluating the efficacy of the therapy used to control the disease process.

What visual field
tests measure

When evaluating visual performance, clinicians are primarily interested in two retinal functions: resolution and contrast sensitivity. Resolution is the ability to identify discrete forms (letters, numbers, symbols), and is commonly measured with the visual acuity test. Resolution rapidly diminishes with increasing distance from the fovea and is, therefore, a poor indicator of overall visual performance.

A better means of evaluating visual function—especially those areas less sensitive than the fovea—is contrast sensitivity testing. Contrast sensitivity is the ability to detect a stimulus (spot of light or other target) against a darker or brighter background. Standard Humphrey perimetry may be thought of as contrast sensitivity testing applied throughout the peripheral visual field.

In perimetry, the term "threshold" is used to describe a very specific level of stimulus detection. The threshold represents the point at which a stimulus is seen 50% of the time and missed 50% of the time. The assumption is that all stimuli brighter than the threshold value will be seen and all stimuli dimmer will be missed. Reviewing the threshold value at each point tested in the visual field is an important part of the diagnostic process.

Visual field tests can yield information that is general in nature, as with screening tests, or more exacting and quantitative, as with threshold tests. In deciding which test type is most appropriate for a patient the practitioner is influenced by many factors, including the patient's presenting complaint, family history, age, degree of cooperation, and time available to run the test.

Normal versus pathologic fields

The visual field normally extends more than 90° temporally, 60° nasally and superiorly, and about 70° inferiorly. That means a person can potentially perceive stimuli within this range while staring at a fixed point.

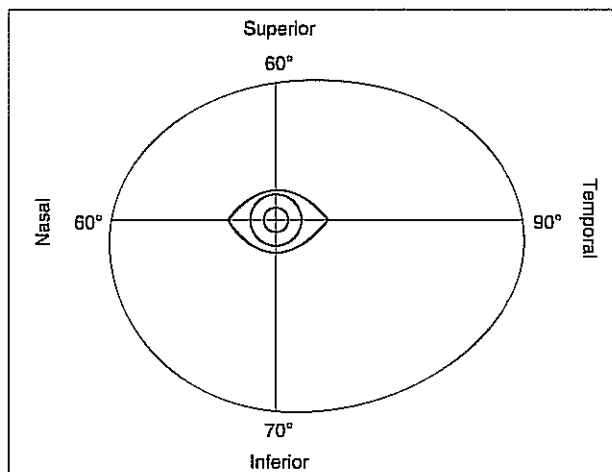

Figure 1.1: The Boundaries of the Normal Visual Field

A more comprehensive understanding of the normal field takes into account that visual sensitivity is not constant (or equal) throughout the range. As previously stated, vision is most acute at the fovea and decreases toward the periphery of the retina. It is easy to see why the visual field is often expressed as a “hill of vision in a sea of darkness”.

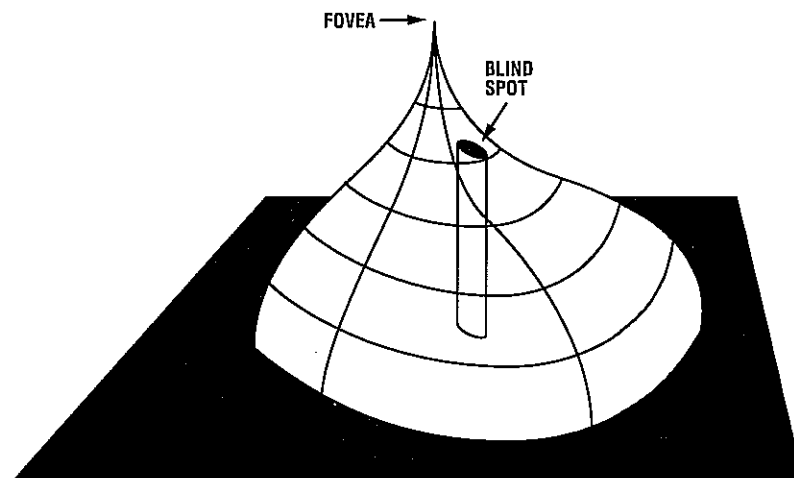

Figure 1.2: The Normal Hill of Vision

Several factors affect the normal hill of vision causing variations in its overall height and shape. Among them are a patient's age, ambient light, stimulus size, and stimulus duration. In general, deviations from the normal hill are viewed as visual field defects and caused by some pathological change.

Methods of testing the visual field

A defect (or scotoma) is categorized as either relative or absolute. A relative defect is an area that has depressed vision or less than normal sensitivity; an absolute defect is an area where the perception of light is absent. The point at which the optic nerve enters the retina is referred to as the blind spot, and is an example of an absolute scotoma.

Some defect patterns are characteristic of certain diseases, a fact which makes visual field testing a valuable part of the diagnostic process. Furthermore, by having patients repeat the same tests at later dates, practitioners gain insight into the progression of the disease and the effectiveness of treatment.

Over the years, visual field testing devices have varied in size, complexity, and testing methodology. The fundamental premise has remained the same, however; patients must respond when they see a stimulus.

In kinetic testing, a target of fixed stimulus characteristics is moved into the visual field from a non-seeing area, until it is detected by the patient. Typically, the target is brought toward the center from several directions and the operator marks the location at which the patient first detects the target (threshold point).

Kinetic test results can only be reliably related to specific parts of the visual field if points are joined to form an isopter, or ring of equal contrast sensitivity. Targets of varying size and brightness are used during one kinetic test, and for each different target, a different isopter is mapped. When reviewing several isopters, the clinician is visualizing different tiers in the hill of vision.

A second method of evaluating retinal function is known as static threshold testing. The term "static" refers to a stationary (rather than moving) stimulus being used.

In static testing, predefined test locations in the visual field are probed. Through a series of stimulus presentations of varying brightness intensities, the threshold value is determined for each test point. When evaluating static test results, clinicians are looking at the topography or contour of the hill of vision, and whether depressions are evident.

Patient fixation and test reliability

In order for any visual field test to be clinically useful, it must yield reliable results. One important factor affecting reliability is the steadiness of patient fixation. Unless the eye being tested accurately fixates on the target while responding to stimuli, the results are unreliable. Other factors adversely affecting reliability are:

- patient fatigue and anxiety
- poor test instructions
- patient discomfort
- improper near vision correction for central testing.

Reasons for
computerized perimetry

Certainly the advancements in microprocessor technology within the last 20 years have had a profound effect on perimetry. Perimeters have evolved into a more precise measuring tool yielding highly repeatable results.

These changes are better appreciated by examining the benefits computerized perimeters bring to both patient and professional:

- Reproducible testing conditions.
- Data storage capability; results can be compared over time and analyzed using expert system software.
- More sensitive testing; many researchers claim static perimetry to be superior to the kinetic method for identifying defects. Performed manually, static testing would be too time-consuming.
- Ease of operation; menu-driven software makes automated perimeters easy to learn and use.

THE HUMPHREY ADVANTAGE

Over 15 years of advancements in research, design and development are reflected in the Humphrey® Field Analyzer II. Equally important, the latest models represent improvements suggested by users from around the world who have generously shared their best ideas with Humphrey Systems. With over 30,000 Humphrey Field Analyzers in use worldwide, Humphrey Systems took on the challenge of improving the testing experience for the patient, the operator, and the practitioner. Here are some of the features which differentiate the HFA II from all other autoperimeters available today.

Ergonomic design

The HFA II relieves many physical discomforts associated with visual field testing. The chin rest and bowl shape allow patients to assume a more natural and relaxed sitting position when taking tests.

The special power table and instrument slider improve patient comfort by permitting the HFA II to extend out to the patient instead of the patient stretching toward the instrument. This is especially important for wheelchair bound patients.

The patient response button is easy to operate, especially for patients who have limited use of their hands; for instance, patients with arthritis. The uniquely-shaped button may be placed on a knee, lap or the arm of a chair for better leverage. The cord angles away from the patient for greater comfort. The response button will beep each time it is pressed to give immediate feedback to the patient and to the user.

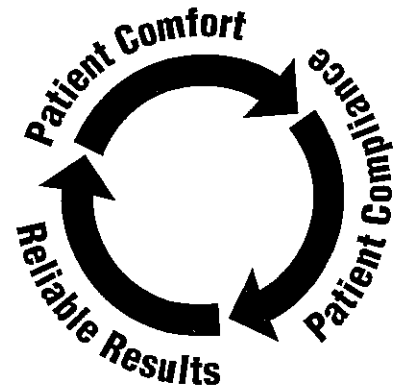

Easy operation

Sophisticated instrumentation need not be complicated. The HFA II offers a number of features intended to make the instrument easier to use:

- Touch screen design speeds data input.
- Menu and icon commands simplify operation.
- On-screen video eye monitor is standard on all models.
- Confirmation screens reduce unintentional data loss.
- A keyboard and trackball or mouse can be connected to the HFA II as optional data input devices.

Speedy testing

Humphrey Systems' SITA™ testing strategies allow precise visual field measurements with unprecedented speed. With the SITA strategies, users can obtain visual field information in half the time it takes using conventional testing algorithms without compromising accuracy. SITA represents the very latest in autoperimetry technology and it is only available with your Humphrey Field Analyzer II.

Sophisticated data analysis with STATPAC™

The Humphrey Field Analyzer's statistical software, STATPAC™, provides immediate expert system analysis of visual field test results. With STATPAC you can analyze test results at the time of examination, store test results and analyze them at your convenience, or recall previously stored tests to analyze for comparative purposes.

STATPAC includes several exclusive features to help you identify visual field change:

- Using results from a single test, STATPAC can point out suspicious areas that otherwise might not be evident until subsequent tests were done.
- STATPAC can identify areas that look suspicious but which, in fact, compare favorably with normals data.
- Using results from a series of tests, STATPAC provides a highly sensitive and informative analysis of changes in the patient's visual field over time.
- The Glaucoma Hemifield Test (GHT) compares points in the superior and inferior hemifields to provide a plain language analysis of test results.
- The HFA II provides separate databases for STATPAC analysis. These include databases for SITA and Blue-Yellow perimetry, in addition to the well-established databases for Full Threshold and FastPac test results.
- Another database consisting of stable glaucoma patients is used with the Glaucoma Change Probability Analysis for following change in the progress of the disease.

STATPAC™ For Windows® is a software program for IBM compatible computers that allows you to analyze patient files in a Windows environment.

**Blue-Yellow (SWAP) testing
(models 745 & 750)**

Blue-Yellow perimetry, also known as Short Wavelength Automated Perimetry, or SWAP, has performed better than standard computerized perimetry according to published longitudinal studies. Working independently, researchers from U.C. Davis and U.C. San Diego have found that Blue-Yellow perimetry identified early glaucomatous visual field defects years before they could be detected using standard white-on-white perimetry.

Blue-Yellow perimetry differs from standard static White-on-White perimetry only in that a carefully chosen wavelength of blue light is used as the stimulus, and a specific color and brightness of yellow light is used for the background illumination. For more information on Blue-Yellow perimetry, see Section 4 and Section 7.

Automatic fixation monitoring

The HFA II employs several methods for ensuring that patients maintain proper fixation of the target during testing. All models are equipped with a video eye monitor which presents a view of the patient's eye on-screen so that users can ensure proper patient fixation. Every HFA II also offers standard Heijl-Krakau blind spot monitoring.

Models 740, 745, and 750 also offer Gaze Tracking: a patented, high precision system which uses real-time image analysis to verify the patient is looking at the fixation target and not looking around. The gaze tracking device is unaffected by the patient's head position. A continuous record of fixation is available for monitoring on the test screen throughout the test. The gaze track graph is included on the printout to provide a permanent record of the patient's fixation.

For patients who require a trial lens, the model 750 uses Head Tracking and Vertex Monitoring to help ensure that the patient's eye is both centered behind the lens and is held at the proper distance from the lens. These features help to eliminate the trial lens as a possible source of unreliable visual field results.

Data protection features

Visual field results need to be saved and protected for future use. The HFA II offers you a number of data storage methods to retain the results. Floppy disk data storage is available with all models of the HFA II. An efficient "floppy backup" procedure can be performed with HFA II models having hard drive capability (models 735, 740, 745 and 750). The HFA II model 750 also has a built-in streamer tape drive which can back up the entire contents of the hard drive in a matter of minutes on a single tape. There are a number of additional data protection features that work internally to safeguard your data from serious loss or damage. This User's Guide describes in great detail the procedures for creating extra copies of your data.

Year 2000 (Y2K) compliance

The HFA II has been programmed from the beginning to be compliant with the year 2000 and Y2K regulations. The internal clock, calendar, data entry screens and statistical analysis software have all been designed to be unaffected by the year 2000.

Information on the internet

Information concerning your HFA II may occasionally be found on the Humphrey Systems' web site. The internet address is : www.humphrey.com

USING THIS GUIDE

To fully appreciate the capability of the HFA II and develop good testing techniques, we recommend that you rely on the User's Guide as your training and reference manual. It has been designed to make learning easy. The concise step-by-step instructions and accompanying illustrations help you get started quickly and with more confidence.

We think you will enjoy working with the HFA II. The friendly touch control makes it inviting to learn and easy to operate. For optimum results:

- Read your guide in the order written.
- Read it while sitting at the instrument.
- Practice using the HFA II by first testing staff members before using it with patients.

Model differentiation

This guide contains operating instructions for Models 720, 730, 735, 740, 745, and 750. Although much of the information is relevant to all models, some information only applies to particular models.

When a feature or function applies to specific models, this guide specifies the model number(s), often in parentheses, in a prominent location. An example of this is found in the previous discussion of Blue-Yellow testing (previous page). Conversely, model numbers are not specified when information is standard or optional on all models.

You can find the model number of your instrument on the rear panel of the HFA II or you may access this information via the "i" button located in the upper, left-hand corner of the screen (see Section 2: "The "i" Button"). If you are unsure about the particular capabilities of your instrument, refer to Appendix A: "HFA II Product Specifications".

Text conventions

The terms "select," "choose," and "press" are used interchangeably. Each term means to initiate an operator action using the touch screen, external keyboard, trackball, or mouse. The terms "hard disk" and "hard drive" are used interchangeably in reference to the data storage device standard on HFA II models 735, 740, 745 and 750.

UPPER CASE LETTERS are reserved for references to specific command buttons found on the touch screen. The exceptions to this are messages on test printouts, the words STATPAC, SITA, HFA II, and headings.

Italicized words are used to identify the icon buttons on the right border of the screen, the titles of figures, pictures, tables, and special notes in this manual.

Bold words are used to highlight warnings and chapter headings.

Additional references

The User Guide cannot possibly cover every situation you may encounter with the HFA II, especially interpretation questions. Your HFA II comes with a copy of *The Field Analyzer Primer* which provides an overview of visual field results. The recently published text, *Automated Static Perimetry, Second Edition*, by Douglas R. Anderson and Vincent Michael Patella (Mosby, Inc., St. Louis), is recommended for in-depth information and analysis of visual fields.

SAFETY PRECAUTIONS

The Humphrey Field Analyzer II complies with UL, CSA, CE and IEC safety requirements. Follow all warnings and precautions to ensure the safe installation and operation of the Humphrey Field Analyzer.

Caution: This instrument is NOT anesthetic-proof. Do NOT use it in the presence of a flammable anesthetic since this creates a risk of explosion!

General safety requirements

- Although the Humphrey Field Analyzer II is designed for continuous operation, it should be turned off and covered with the dust cover when not used for an extended period of time. The HFA II should be used in a cool, dry and dust-free setting.
- The HFA II is classified as type B, class I protection equipment. To prevent electric shock, the instrument must be plugged into an earth grounded outlet.
- Do NOT connect or disconnect cables while power is on.
- Do NOT place any objects on top of the instrument.
- Do NOT place any container holding liquid near the instrument.
- Do NOT place the dust cover on the instrument while the instrument is powered on.

Installation safety precautions

- The Humphrey Field Analyzer II is equipped with a three-prong plug. The instrument should be plugged into a correctly wired outlet with a ground receptacle. If the plug does not fit the outlet, contact an electrician. Do NOT disable or remove the ground pin.
- Do NOT overload your AC outlet.
- If the cord or plug is damaged, do NOT continue to use the instrument. Electrical shock or fire hazard may result. Call Humphrey Customer Service for replacement.
- Do not block the ventilation openings. These allow for the release of heat generated during operation. A buildup of heat due to blockage can cause failures which may result in a fire hazard.
- Use only a stand or table recommended by Humphrey Systems.
- If the stand or table has casters, do NOT try to roll it in deep pile carpet or over objects on the floor such as cables and power cords. Lock the casters to secure the table.
- Do NOT place the instrument on an uneven or sloped surface.
- Do NOT use accessories that are not designed for this instrument. Use only those parts recommended by Humphrey Systems to achieve optimum performance and safety. Accessories must meet UL, CSA, CE, and IEC safety standards.
- Do NOT use the instrument in or near wet or moist environments.

Caution: Always replace fuses with same type or rating. Failure to do so may create a fire risk. Refer to fuse ratings listed on the label on the rear panel of the instrument or on the table near the fuse holder.

Radio and TV interference

The Humphrey Field Analyzer II has passed all domestic and international electromagnetic emission/suppression standards. However, it still generates small amounts of radio frequency energy and may cause interference to radio, television or other instruments. If the HFA II does cause interference to radio or television reception, the following measures may be necessary:

- Plug the Humphrey Field Analyzer II into a different outlet so that the instrument and the receiving device are on different branch circuits.
- Reorient the HFA II with respect to the TV or the radio antenna.
- Move the receiving device and the HFA II away from each other.
- Use only shielded communication cables.

Power on

The power switch is located on the rear panel of the instrument. Once engaged, the HFA II begins performing a self-diagnostic checkup. In the event the computer detects a problem, a message will appear on the start-up screen. Call Humphrey Customer Service if necessary.

SYSTEM COMPONENTS

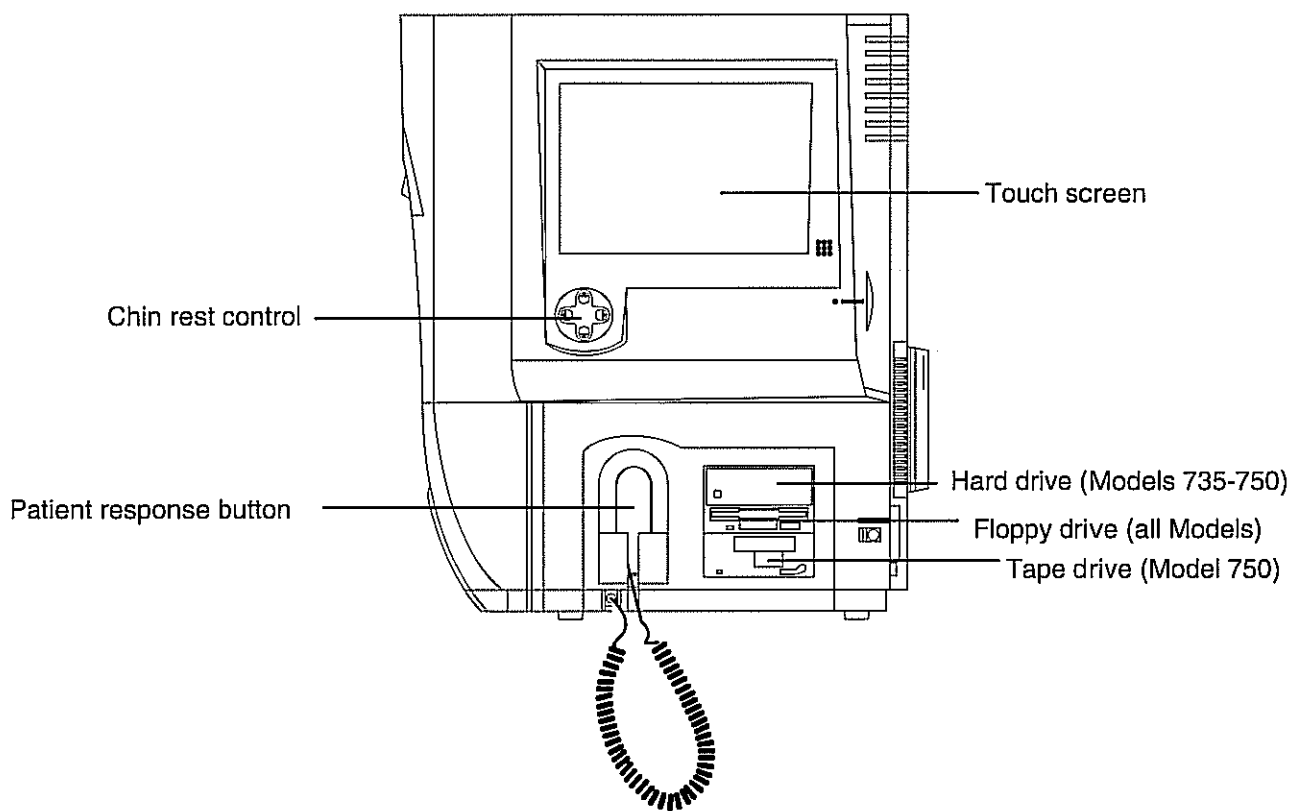

Figure 1.3: The HFA II – Side View

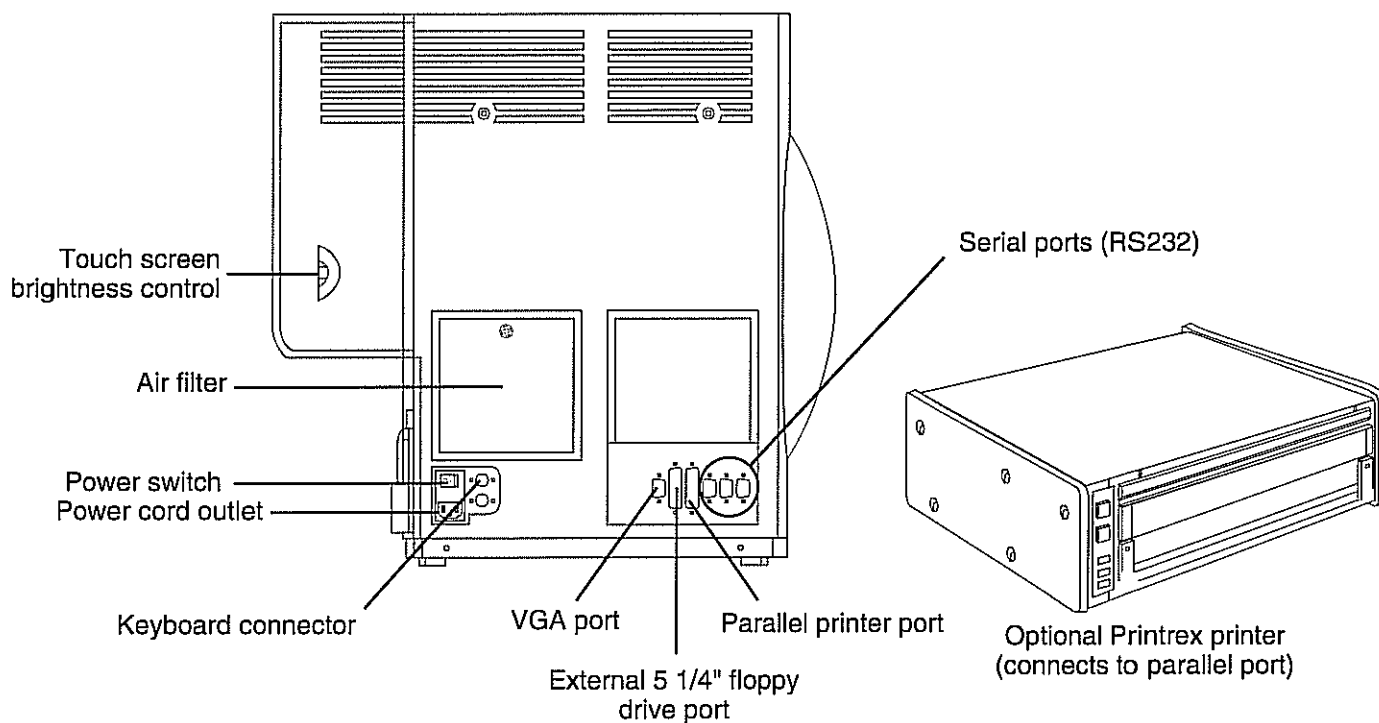

Figure 1.4: The HFA II – Rear View

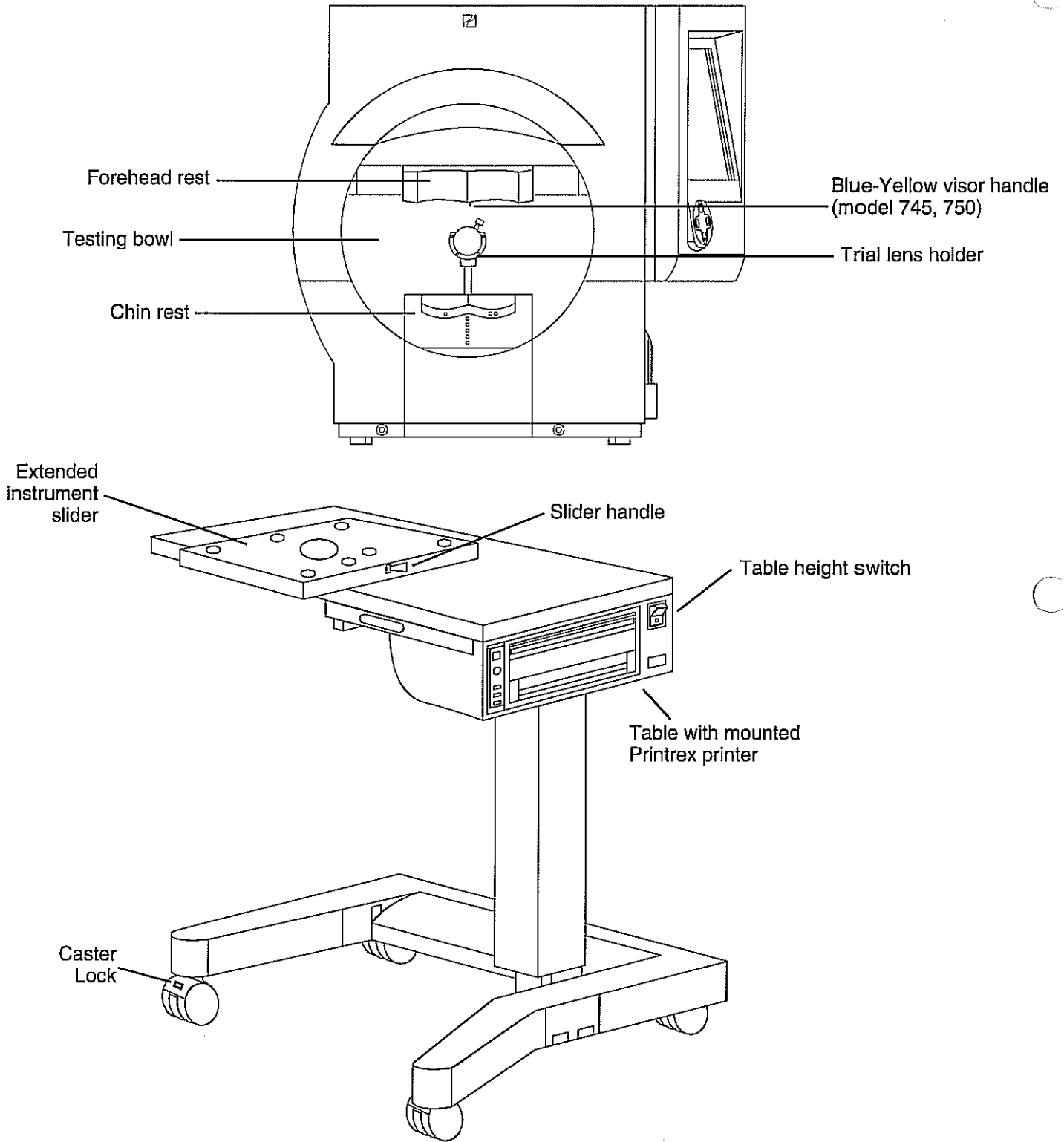

Figure 1.5: The HFA II – Front View with Instrument Table

Symbol definitions

The following symbols appear on the HFA II:















	Power On		Brightness
	Power Off		VGA Monitor
	Important Instructions Found In The Manual		Projector Bulb
	Uninsulated High Voltage Inside The Instrument. Risk Of Electric Shock.		Serial RS-232 Communication Port
	Fuse		Printer
	Parts Of The Instrument That Touch The Patient Are Of Type B According To The IEC Standard.		Keyboard
			Patient Response Button
			Floppy Disk Drive
			Air Intake Filter

Figure 1.6: HFA II Symbol Definitions

OPTIONAL COMPONENTS

Printers

Several printers are currently supported by the HFA II:

- **Printrex Thermal Line Printers**
 - Table-Mounted Model (standard with HFA II)
 - Stand-Alone Model (optional)
- **Hewlett-Packard LaserJet Printers (optional):**
 - 2, 2P, 2P+, 3, 3P, 3P+, 4, 4L, 4MP, 4P, 5L, 5P, 6L, 6P

Printrex: Table-Mounted and Stand-Alone Model

1. With power off to the table and HFA II, connect the printer interface cable to the parallel port on the HFA II. Refer to Figure 1.4.
2. Insert paper supply. Refer to Section 12: "Loading Paper".
3. Turn on power to the table.
4. Turn on power to the HFA II.
5. From the System Setup screen, select PRINTREX. See Section 2: "Selecting the Printer Type."

Hewlett-Packard LaserJet

Before you start, check that you have the following supplies:

- HP LaserJet printer
 - Interface cable
 - HP printer manual
 - Toner cartridge
 - Printer paper.
1. With power off to the HFA II, connect the interface cable to the respective parallel port on the HFA II (refer to Figure 1.4) and the printer (refer to Hewlett-Packard printer manual).
 2. Install the toner cartridge.
 3. Insert paper supply.
 4. Connect the printer power cord to the HFA II table or to a wall outlet.
 5. Turn on power to the printer and the HFA II.
 6. At the System Setup menu, select HP LASERJET. See Section 2: "Selecting the Printer Type".

External keyboard

The HFA II supports an external keyboard. The keyboard is a standard feature of the Model 750 and is optional for all other HFA II models. The keyboard plugs into the back of the HFA II near the power switch (refer to Figure 1.4 for the location of the plug).

1. Power off the HFA II (keyboard will not work if connected with power on).
2. Plug in the keyboard.
3. Power on the HFA II.

While any standard PC-type keyboard may be plugged into the HFA II and should work, we can only guarantee compatibility with the keyboard shipped to you by Humphrey Systems. See Section 2: "Using the External Keyboard" for more details.

Trackball, mouse,
or other input device

It is usually possible to use a Microsoft™-compatible serial trackball, mouse, or other external input device with your HFA II. These devices may be used as an alternative to pressing the touch screen. They may be used in conjunction with the optional external keyboard. The keyboard is not necessary to utilize these devices. For simplicity in describing the feature, the term "trackball" will be used to represent any compatible input device.

The serial trackball is connected to Serial Port 3 on the back of the HFA II. You may need to use an adapter (a DB 9 male-to-male gender changer). Adapters can be purchased at most computer or electronics stores. Humphrey Systems does not sell these adapters. Figure 1.7 indicates the proper serial port on the back of the HFA II where the trackball connects. Also see Figure 1.4 for additional help locating the serial ports. **The HFA II must be turned off when attaching or removing any input device.** See Section 2 for use of the trackball.

Note: The Microsoft PS/2 mouse is not supported by this product.

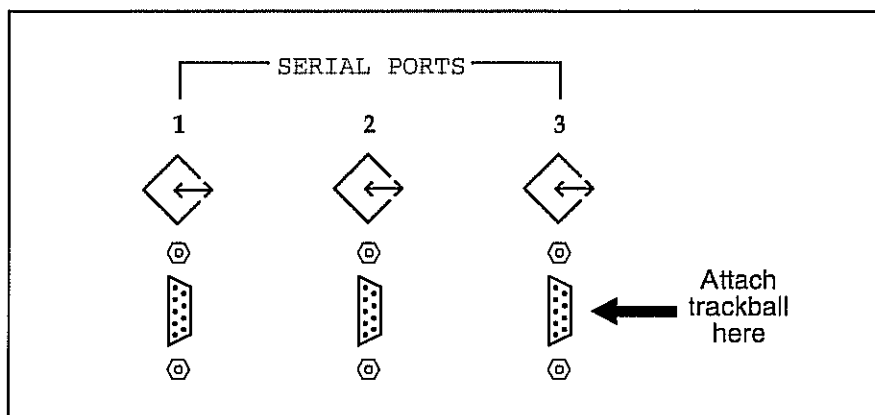

Figure 1.7: Serial Port Connection for the Trackball (back of HFA II)

External 5.25" floppy
disk drive

An external 5.25" floppy disk drive is available from Humphrey Systems for transferring tests between the HFA I and the HFA II. See Section 8 for details.

External VGA monitor

Your HFA II allows you to connect an external VGA monitor. Commands issued with the keyboard and trackball/mouse can be seen on the external screen. Touch screen capability is not available on the external monitor. The HFA II touch screen remains available for use when using the external monitor. Output to the external monitor will display in black & white, even when using a color monitor. Connection of the VGA monitor is made to the port found on the back of the HFA II (see Figure 1.4 for location).

Surge protectors

Humphrey Systems recommends the use of surge protectors or UPS (Uninterruptable Power Supply) systems to help isolate the HFA II from power surges or fluctuations. The HFA II is very sensitive to line voltage changes and may experience database problems if subjected to brownouts, power outages or surges of voltage. Hospitals, surgery centers, and offices with instruments which consume large amounts of power, such as lasers, should be especially careful to plug the HFA II directly into a UPS or adequate surge protector. Humphrey Systems recommends a system with a rating of 400 volt amps or greater.

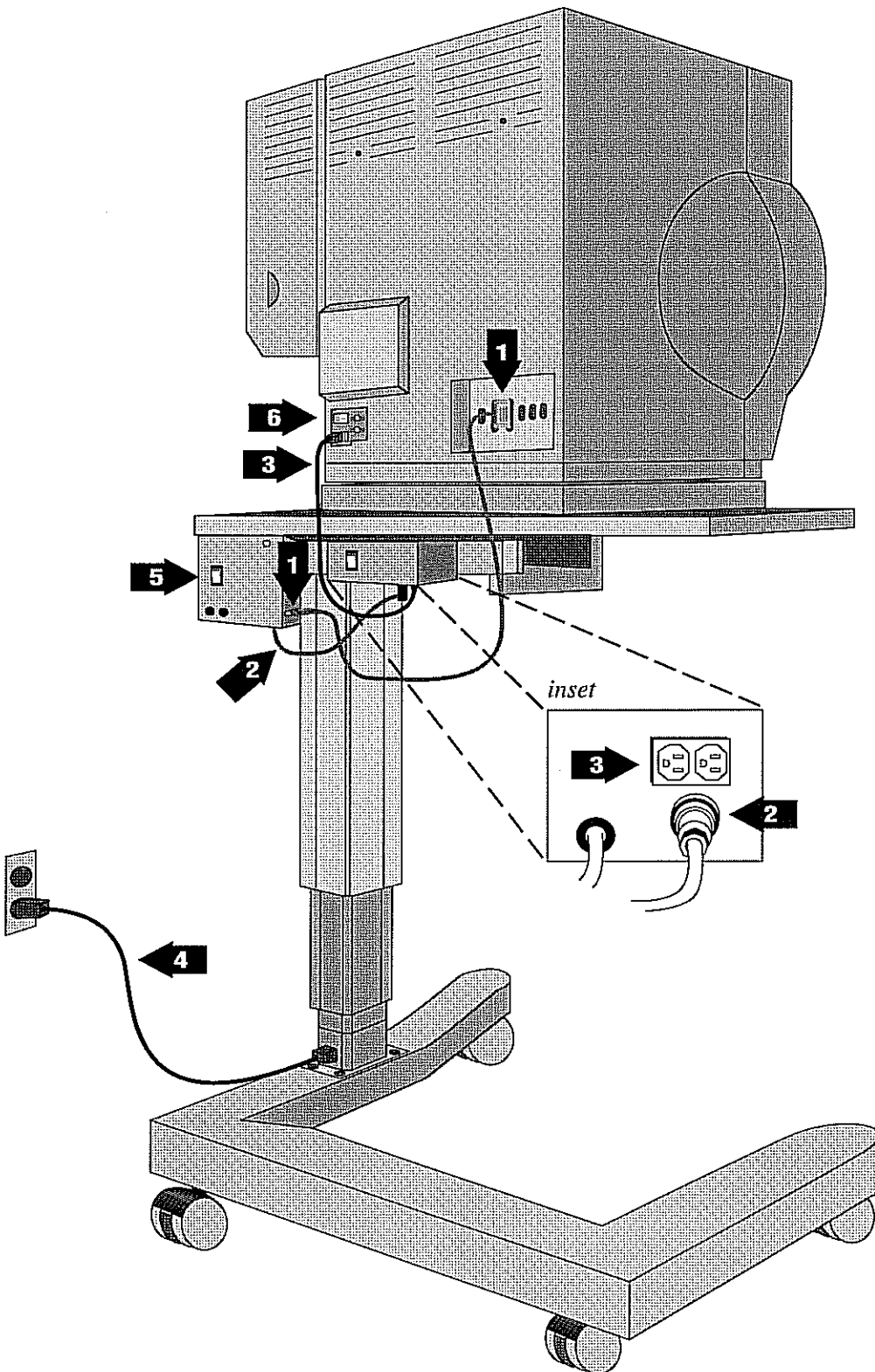
SYSTEM
ASSEMBLY

1 Connect printer cable to Printrex printer and HFA II at rear of unit (see Figure 1.4: Parallel Printer Port).

2 Attach Printrex power cord to special outlet on underside of table. See inset.

3 Connect power cord from back of HFA II to power outlet on underside of table.

4 Attach power cord at base of table and connect to wall outlet.

5 Turn on power to the Printrex printer.

6 Turn on power to the HFA II.

Figure 1.8: The HFA II – Rear View on Instrument Table

General Information	2-2
The Main Menu Screen	2-9
System Setup	2-10
Additional Setup	2-21
Help Screens	2-23

This section covers general operation of the HFA II. It describes how to execute commands, input information, and customize the HFA II to suit your needs.

After reading Section 2 you will be familiar with:



- command buttons and icons on the HFA II screen
- using the Main Menu screen to select tests
- personalizing printouts with the name of your practice
- setting the internal clock and calendar
- customizing the test buttons displayed on Main Menu screen
- using the optional keyboard.

GENERAL INFORMATION

Screen simplicity

Almost every screen is divided into three areas: the Title Bar, the Screen Body, and the Icon Buttons.

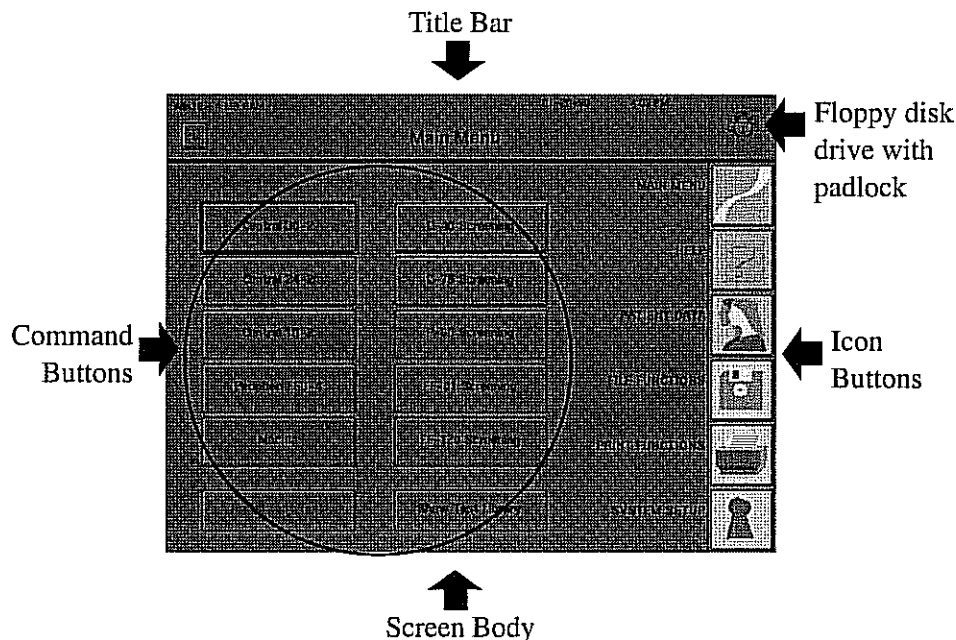

Figure 2.1: Main Areas of the HFA II Screen

The Title Bar

This area is the top portion of every screen. The middle of the title bar displays the name of the screen in bold type. The left side shows the system software version and the “i” button. More information about the “i” button appears later in this section. The right side displays the current date, time, and a picture that shows if the floppy disk in the drive is in use. **Do not insert or remove a floppy disk when the padlock is displayed on the screen as shown above.**

Operator messages may appear in the top right corner of the Title Bar or the center of the Screen Body to inform you of a condition or alert you to a problem. “Printer is not connected or Off Line” and “Uninitialized Disk” are examples of operator messages. Multiple messages may appear stacked and overlapping in the upper right corner. Touching the top message collapses it, revealing the previous message.

The Screen Body

The Screen Body comprises the largest part of every screen. This is where most of the commands are issued via command buttons. The contents of the Screen Body changes after every command. The Screen Body is referred to as the “screen” throughout the User’s Guide.

Frequently, a button will appear dimmed or “ghosted.” This indicates either that the button function cannot be activated from that screen or that the button represents a feature that is not available on the HFA II model being used. For example, the MOVE TESTS button on the model 720 HFA II has been ghosted because this option is not available on the model 720 and is, therefore, nonfunctional.

Icon buttons

These buttons occupy the right side of most screens. Each has a unique function that can be accessed at any time unless there is a pop-up window present or the icon buttons are ghosted. See "Pop-up Windows" later in this section for details. The HFA II's icon buttons are shown below along with a brief description of their function.

**MAIN MENU**

The *MAIN MENU* icon allows you to return to the Main Menu screen from other system screens.

**HELP**

The *HELP* icon gives brief explanations of certain features and procedures available on the HFA II. You should always consult this Guide for further information.

**PATIENT DATA**

PATIENT DATA leads you to the Patient Data screen where you may enter or recall the patient's name, date of birth, I. D. number, trial lens information, and diagnostic data prior to testing. Main Menu test buttons also automatically lead you to the Patient Data screens.

**FILE FUNCTIONS**

Through *FILE FUNCTIONS* you can access the patient test results that have been saved as well as perform various database management procedures.

**PRINT FUNCTIONS**

PRINT FUNCTIONS allows you to print out hard copies of test results in various styles.

**SYSTEM SETUP**

SYSTEM SETUP lets you define certain user settings. Examples of these are time and date, printer type, visual acuity format, and practice name and address on printouts. Access to the *SYSTEM SETUP* icon is only available from the Main Menu screen.

**UNDO**

The *UNDO* icon takes you back to the previous screen. In some cases pressing the *UNDO* icon will appear to take you back two screens. This occurs when the previous screen is a pop-up window. The *UNDO* icon is not available on the Main Menu screen.

The "i" button
(Information)



The "i" button is present on most screens and can be found in the upper left corner of the screen. Pressing this button brings you to the Unit Configuration screen which contains information useful when contacting Humphrey Customer Service. If the video eye monitor is displayed, you will need to turn the monitor OFF to access the "i" button.

The following information is displayed when the "i" button is pressed:

- Model Number
- Serial Number
- Operating System-Revision Number
- Language
- Hardware Options
- Software Options
- Personalized Information such as user's name, address, and telephone number.

The Unit Configuration information may be printed by pressing the PRINT button. To return to the previous screen, touch CANCEL.

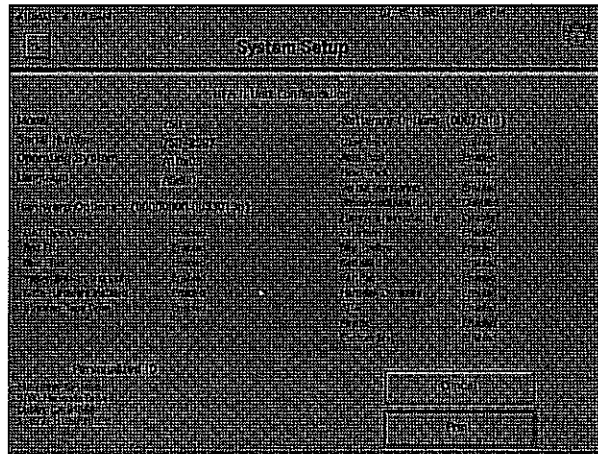

Figure 2.2: The Unit Configuration Screen.

Touch screen

Operating the HFA II is literally at your fingertips. You can perform all functions, whether entering data or selecting a test, by simply touching a command button on the touch screen. **While using the touch screen, the HFA II is activated when your finger is removed from the button you select. Be careful not to pound or press too hard against the touch screen. A light touch works best.** An audible beep will alert you of successful button activation.

If you have difficulty activating the touch screen, consider re-calibrating it. Details on calibrating the touch screen are found in "Additional Setup" later in this section as well as in Section 12: "Touch Screen Calibration".

You may also opt to navigate through the system with the help of the keyboard function keys. F1 through F6 serve as keyboard equivalents of the icon buttons. The function keys and the associated icon buttons they activate are listed below:

F1	<i>HELP</i>
F2	<i>MAIN MENU</i>
F3	<i>PATIENT DATA</i>
F4	<i>FILE FUNCTIONS</i>
F5	<i>PRINT FUNCTIONS</i>
F6	<i>SYSTEM SETUP / UNDO</i>

Using the trackball, mouse,
or other input device

It is possible to use any Microsoft™-compatible serial trackball, mouse, or other external input device on your HFA II. These devices may be used as an alternative to pressing the touch screen. They may be used in conjunction with the optional external keyboard, although the keyboard is not necessary to utilize these devices. For simplicity in describing the feature, the term "trackball" will be used to represent any compatible input device. See Section 1: "Optional Components" for directions on connecting the trackball or mouse.

Using a trackball with the HFA II is very similar to using this device with a business or personal computer. Trackballs vary, so experiment with your trackball to determine which button may be used. If using a mouse, only the left-most button is active. Other buttons do not function with the HFA II.

The trackball is used in conjunction with the square cursor, which appears as a small, movable box on the video screen of the HFA II. The cursor moves as you move the trackball. Items are selected by moving the cursor to the desired item and pressing (or clicking) the left-most button on the trackball (or appropriate mouse button). To ensure that the appropriate item is selected, make sure that the cursor is completely within the boundary of the desired item.

To select an item on a drop-down menu, move the cursor to the desired drop-down box. Click the trackball button. The drop-down menu will appear. Drag the cursor down to the desired item until that item is highlighted. Press the trackball button again. The drop-down menu will disappear and the selected item will appear in the drop-down box, indicating that it has been selected. This procedure is identical to selecting menu items on many popular computer programs.

Note: The cursor may not always be visible. To locate the cursor, either move the trackball or press a keyboard button. It is not recommended to press the SPACE BAR or RETURN key, as these will activate the highlighted screen button.

A file directory appears whenever the user wants to perform a specific function with previously saved tests. Buttons such as VIEW TESTS, COPY TESTS, and CHANGE PATIENT DATA will bring up directories. To select specific items on a directory, move the cursor to the desired item. Click the trackball button to highlight this item. If more than one item can be selected, such as with the COPY TESTS feature, a check mark (✓) will appear next to the item to indicate that it has been selected.

Several items in a row can be selected at one time by holding down the trackball button, dragging the cursor to highlight and check (✓) several items, and then letting go of the button. After dragging, only the last item will remain highlighted; however, each item selected will have a check mark next to it.

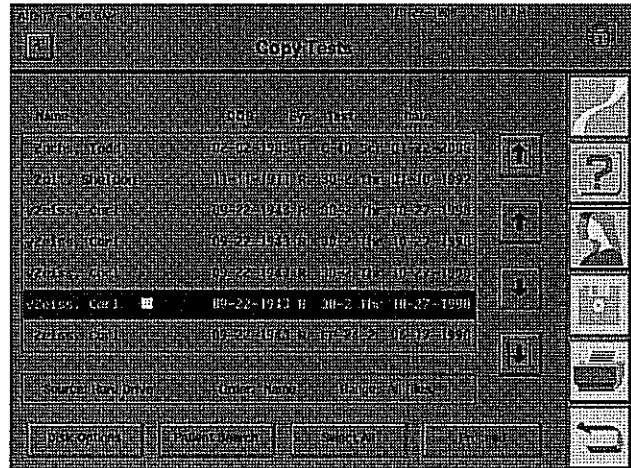

To deselect a chosen item, move the cursor to a highlighted or checked (✓) item and click the trackball button. The check mark next to the item will disappear.

Screen saver

The HFA II features a screen saver to extend the life of the video screen. It activates after the HFA II has been idle for 10 minutes. The screen saver will disappear when the touch screen is pressed, a key on the external keyboard is pressed, or the trackball is moved.



Figure 2.5: The Screen Saver

THE MAIN MENU SCREEN

When the HFA II is turned on, the first screen displayed, after the start-up sequence, is the Main Menu screen. Its primary functions are to display a series of test buttons (from which you initiate the testing procedure), allow recall of the last test performed, and provide access to the System Setup screen. A further explanation of Main Menu functions follows Figure 2.6 below.

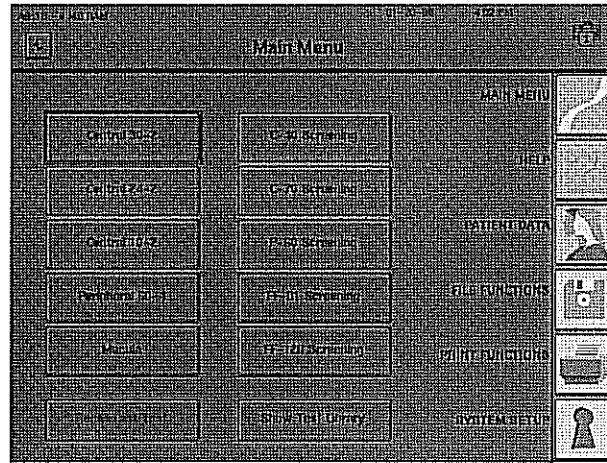

Figure 2.6: The Main Menu Screen

Command buttons



A Test Button

Each test button displays the name of a test. Pressing the test button allows you to choose the eye to be tested. See Section 3: "Using Test Buttons" for more information.

Recall Last Test

This button accesses the results from the last right and left eye tests performed. When the HFA II is first powered on, this button appears ghosted. It will remain inaccessible until a test has been run. The memory is cleared when the instrument is turned off.

Show Test Library

This button leads to a list of all available test patterns, including Screening, Threshold, Specialty, Custom, and Kinetic tests. When you want to select a test not found on the Main Menu screen, choose the SHOW TEST LIBRARY button. See Section 3: "The Test Library" for details.

The Main Menu test buttons may be customized to reflect your needs. Any test in the Test Library may be placed on the Main Menu screen. Buttons which are not used very often may be removed. A second line of text can be added to test buttons to differentiate tests with the same name but having different parameters. See "Altering the Main Menu Screen" for additional information.

SYSTEM SETUP



The System Setup screen is accessed by pressing the *SYSTEM SETUP* icon located on the Main Menu screen. You may choose from a variety of selections on the two System Setup screens: the main System Setup screen shown in Figure 2.7 and the Additional Setup screen illustrated in Figure 2.8. Your selections will determine the mode in which your HEA II will power-up. An explanation of the System Setup functions and procedures to alter the settings are described on the following pages.

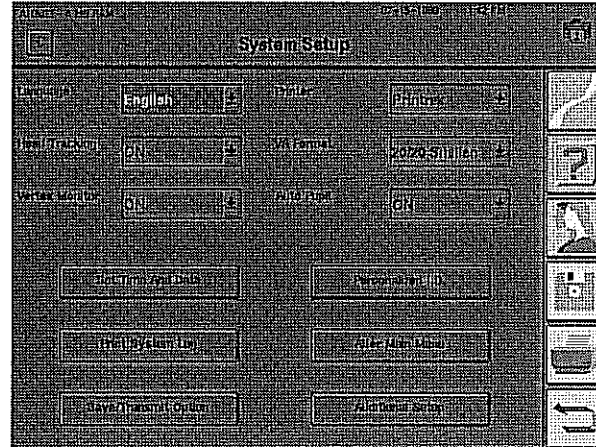

Figure 2.7: The Main System Setup Screen



Language

The HEA II allows you to choose among English, German, Spanish, French, Italian and Japanese languages. If you select a different language from the current language set, the HEA II will automatically reboot in that language. The original language must be re-selected in order to be reactivated.



Head Tracking (model 750 only)

When Head Tracking is turned ON, the instrument moves the chin rest during a test to keep the patient's eye centered behind the trial lens holder. This action helps to reduce trial lens artifacts (test points being blocked from the patient's view by the edge of the trial lens). This feature only works if Gaze Tracking has been successfully initialized and the trial lens holder is in the Up position. For more information see Section 5: "Head Tracking".



Vertex Monitor (model 750 only)

When the Vertex Monitor is turned ON, a beep is sounded and a message is displayed if the patient's head is too far back from the trial lens during a test. This helps to eliminate the trial lens as a source of visual field defects. This feature only works if Gaze Tracking has been successfully initialized and the trial lens holder is in the Up position. For tips on using this feature, see Section 5: "Vertex Monitor".



Set Time and Date

This allows you to reset the instrument's internal clock and calendar in a format appropriate for your geographic region. Accurate date information is critical for correct STATPAC analysis, age-corrected screening tests, and proper trial lens calculations.



Print System Log

The system log prints the instrument serial number and configuration options along with messages occurring in the HEA II. This feature is designed to be used by Humphrey Field Service representatives. Should you experience a problem with your instrument, it is a good idea to print the system log before calling Humphrey Customer Service.



Save/Transmit Option

This option allows the user to change the SAVE button functionality on the End of Test screen. Choices are Transmit Only, Save Only, or Save and Transmit. Transmit allows the user to send (transmit) data via a serial interface cable to an outside computer system at the end of every test.



Printer

This option allows you to designate the printer type to be used with your instrument. The choices are HP LaserJet and Printrex. The HEA II supports the following HP LaserJet Models: 2, 2P, 2P+, 3, 3P, 3P+, 4, 4L, 4MP, 4P, 5L, 5P, 6L, and 6P.



VA (Visual Acuity) Format

Select 20/20 Snellen, 6/6 Metric, or 1.0 Decimal as the visual acuity format used when entering patient data.



Auto Pupil (model 750 only)

If Auto Pupil is set to ON, the HEA II will automatically take a measurement of the patient's pupil diameter and enter the finding on the Patient Data 2 screen. An asterisk (*) is added whenever the measurement was made automatically. Manual pupil measurement input is displayed without an asterisk. The pupil diameter will also appear on the printout. This feature only works if Gaze Tracking has been successfully initialized. For more information on Gaze Tracking, see Section 5: "Gaze Tracking".



Personalized I.D.

This allows you to customize hard copy printouts with 5 lines of text (e.g. practice name, address, and telephone number).



Alter Main Menu

This allows you to customize the Main Menu screen by adding test buttons which normally are only accessible through the test library, by deleting test buttons which are not often used, or by altering test buttons to power-up with your preferred testing parameters. Additional text may be added to further describe the parameters or usage of customized buttons. See "Altering the Main Menu Screen" for details.



Additional Setup

This allows you to access additional System Setup functions located on the Additional Setup screen.

Accessing the system setup screen

- 1 Start at the Main Menu. Select the *SYSTEM SETUP* icon.

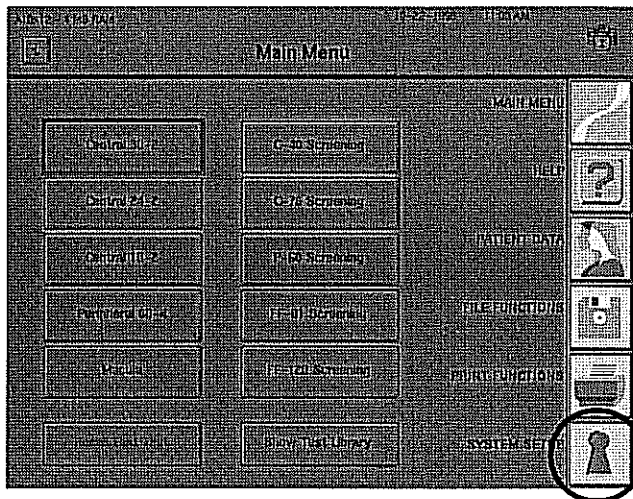

- 2 Choose the desired function.

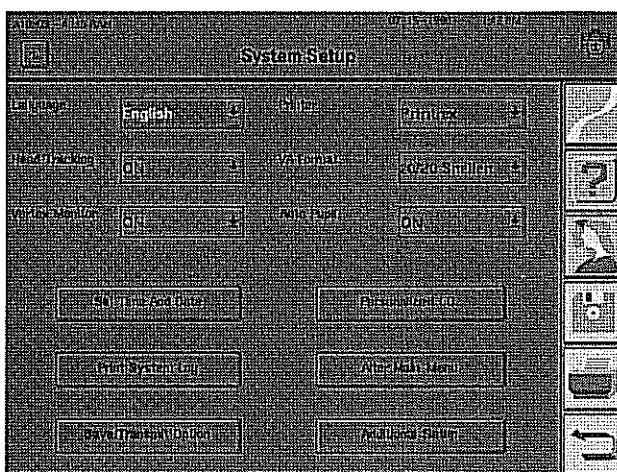

Altering the language

- 1 Start at the System Setup screen. Select the language drop-down menu.

- 2 Choose from English, German, Spanish, French, Italian, or Japanese. Once a language has been selected, the instrument will restart in order to change parameters.

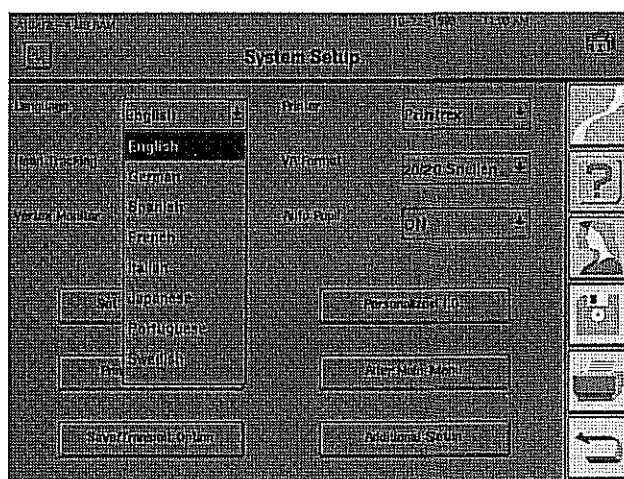

If a foreign language is selected inadvertently, select the *SYSTEM SETUP* icon (bottom right-hand corner of the Main Menu). When the System Setup menu appears, select the top left-hand drop-down menu and select the first option item to return to English.

Accessing head tracking
(model 750)

- 1 Start at the System Setup screen. Select the Head Tracking drop-down menu.
- 2 Choose between ON and OFF.

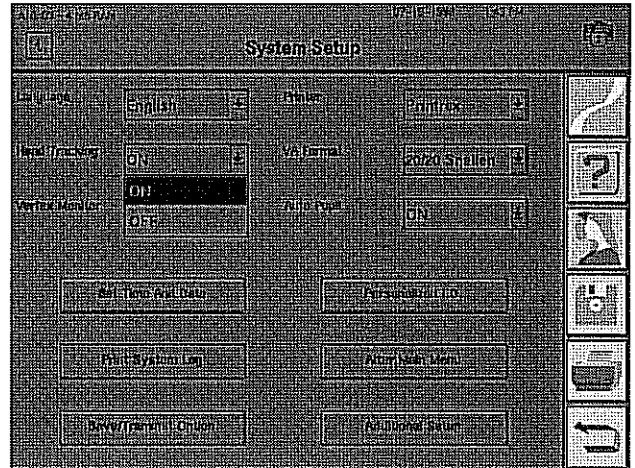

Note: If Head Tracking is turned on during testing and the patient moves, the instrument will adjust the chin rest in small, 0.3 mm increments until the patient returns to the original position. This feature only works if Gaze Tracking has been successfully initialized and the trial lens holder is in the Up position. For additional information, see Section 5: "Head Tracking".

Accessing the vertex
monitor (model 750)

- 1 Start at the System Setup screen. Select the Vertex Monitor drop-down menu.
- 2 Choose between ON and OFF.

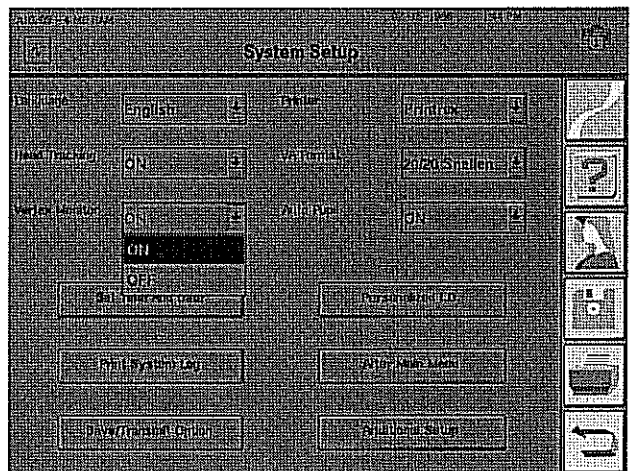

Note: When the Vertex Monitor is turned on, a beep will sound if the patient has backed away from the trial lens during testing. Although the test will not pause, a message will remain on the screen until cleared by the operator. This feature only works if Gaze Tracking has been successfully initialized and the trial lens holder is in the Up position. For additional information, see Section 5: "Vertex Monitor".

Setting the time and date

1 Start at the System Setup screen. Select SET TIME AND DATE.

2 Select the Time Format drop-down menu.

Choose 24 HOURS or AM/PM from the drop-down menu.

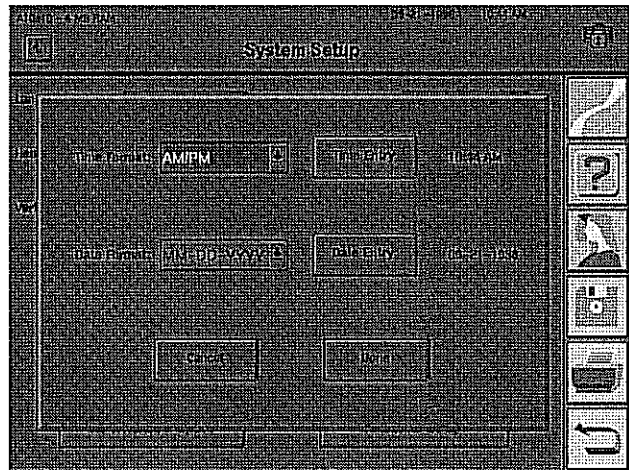

3 Press TIME ENTRY. Input the correct time on the keypad, then press ENTER.

Note: If you have selected AM/PM format, you must enter either AM or PM with the time entry.

4 Select Date Format. Choose MM-DD-YYYY, DD-MM-YYYY or YYYY-MM-DD from the drop-down menu. Your HFA II is Year 2000 (Y2K) compliant.

Note: MM= Month, DD=Day and YYYY=Year.

5 Select DATE ENTRY. Input the correct date from the keypad, then press ENTER.

Note: The time and date display appears in the upper right-hand corner of the screen in the format determined above.

Printing the system log

1 Start at the System Setup screen. Select PRINT SYSTEM LOG.

2 The instrument will automatically start to print the System Log.

Note: Length of time to print log will vary depending on system log size.

Accessing the save/transmit option

1 Start at the System Setup screen. Select the Save / Transmit Option drop-down menu.

2 You may choose from SAVE ONLY, SAVE AND TRANSMIT, or TRANSMIT ONLY. SAVE ONLY returns you to the System Setup screen.

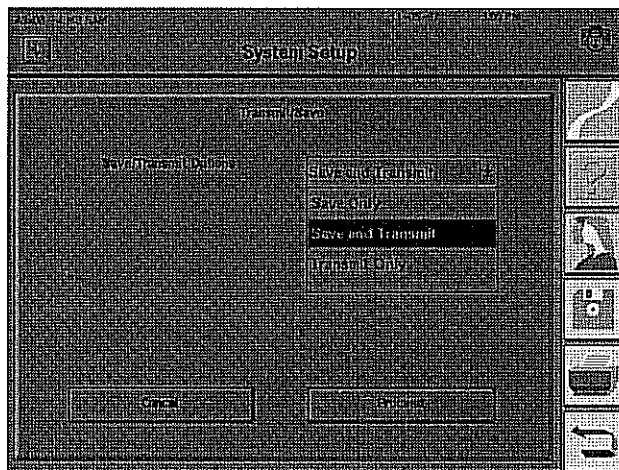

3 After choosing SAVE AND TRANSMIT or TRANSMIT ONLY, select RS-232 Options for transmission. The RS-232 Setup screen will appear.

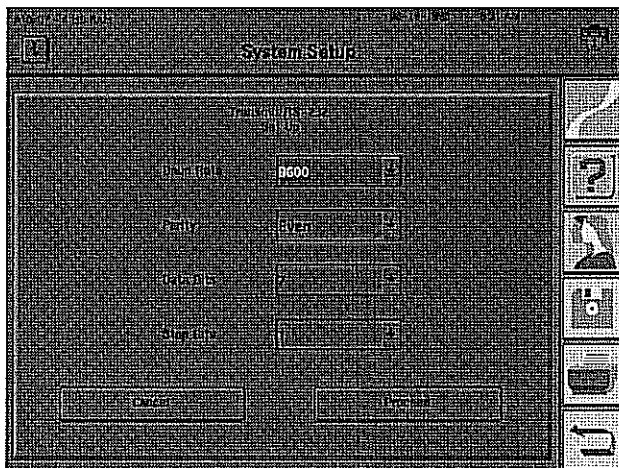

4 Select the Baud Rate, Parity, Data Bits and Stop Bits as required for transmission. The following choices are available:

Baud Rate	300, 600, 1200, 2400, 4800, 9600 , 19200		
Parity	none	odd	even
Data Bits	0	7	8
Stop Bits	0	1	2

For compatibility with other Humphrey products (STATPAC™ for Windows, HEA 600 series instruments) you must transmit data using 9600 Baud at Even parity with 7 data bits and 1 stop bit.

5 Select PROCEED to save the changes or CANCEL to restore the previous values. Return to the System Setup menu.

Selecting the printer type

1 Start at the System Setup screen. Select the Printer drop-down menu.

2 Choose between HP LASERJET and PRINTREX.

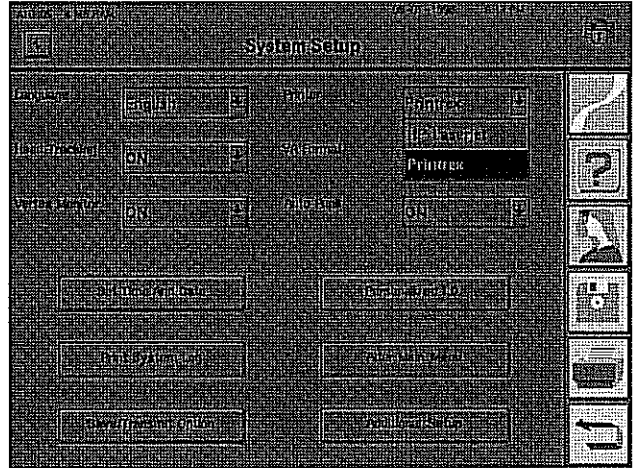

Selecting a visual acuity format

1 Start at the System Setup screen. Select the VA Format drop-down menu.

2 Choose from 20/20 SNELLEN, 6/6 METRIC, or 1.0 DECIMAL.

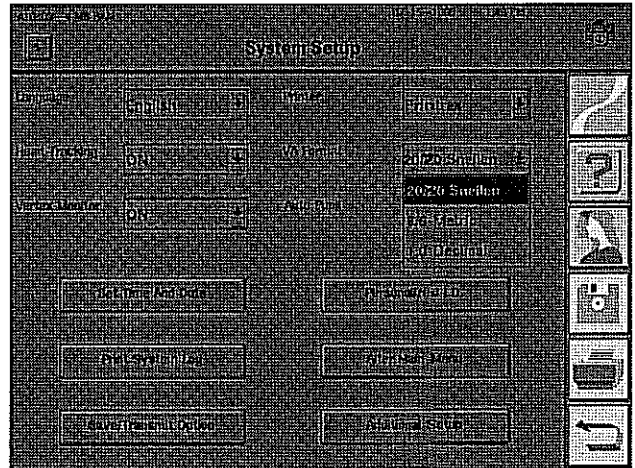

Selecting auto pupil
(model 750 only)

1 Start at the System Setup screen. Select the Auto Pupil drop-down menu.

2 Choose between ON and OFF.

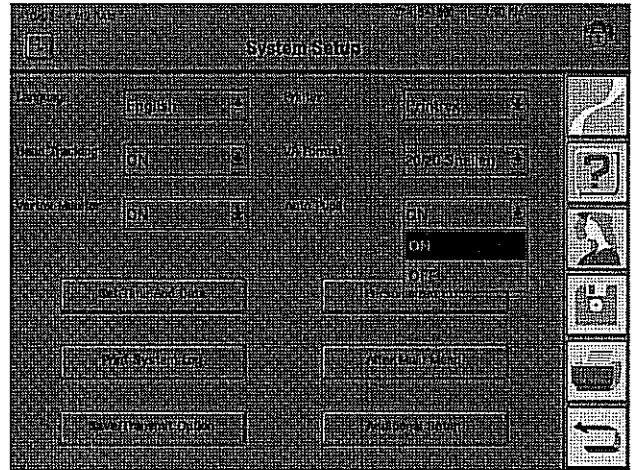

Note: Auto Pupil only works if Gaze Tracking has been initialized. For information on Gaze Tracking, see Section 5: "Gaze Tracking".

Personalizing hard copy
printouts

1 Start at the System Setup screen. Select PERSONALIZED ID.

2 Select the line button where you wish to enter text.

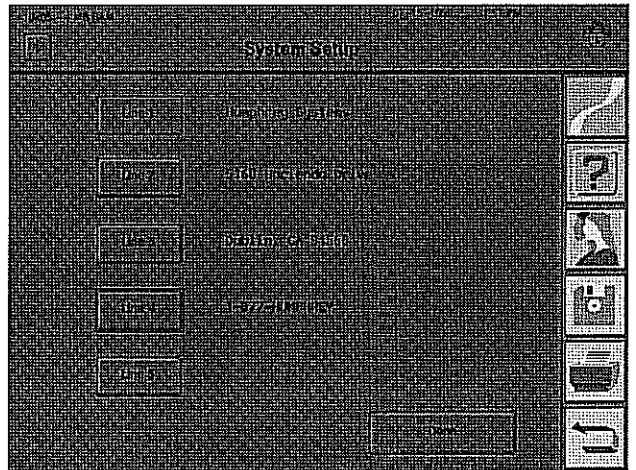

3 Enter the desired text (maximum of 40 characters per line).

4 Repeat steps 2-3 for other lines.

Altering the Main Menu screen

1 Start at the System Setup screen. Select ALTER MAIN MENU.

2 Press ADD/CHANGE A BUTTON.

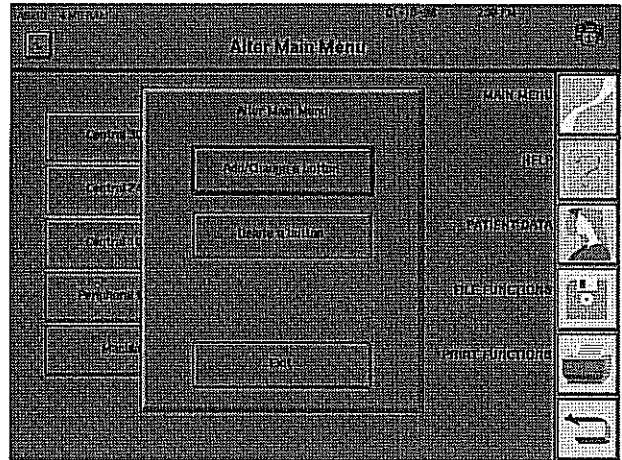

3 Select the button position where the change is to take place.

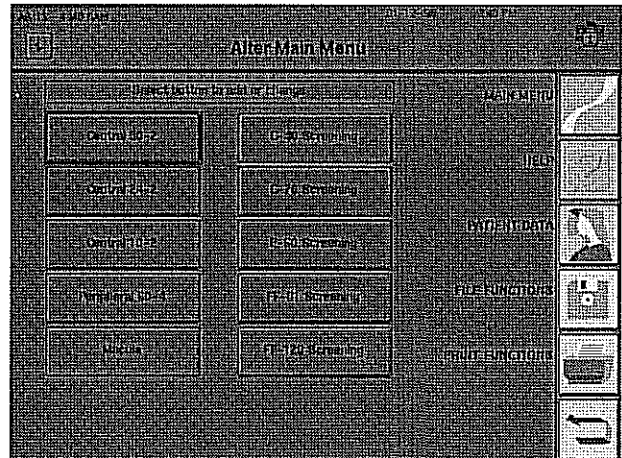

4 Choose from any test type, including SCREENING, THRESHOLD, SPECIALTY, CUSTOM, and KINETIC tests. After selecting, the same Test Library screens normally accessed through the Main Menu screen will appear.

5 Select the test pattern that you wish to add or change. The Parameter Setup screen will appear. All test buttons start with standard parameters.

6 Change the existing parameters to fit your needs. Finalize your choices by pressing SELECTION COMPLETE.

7 You may add a second line of text to the button to differentiate it from other buttons. This line will appear below the name of the test.

If you want to add a second line of text, press YES when prompted. Use the pop-up keyboard to type the additional information.

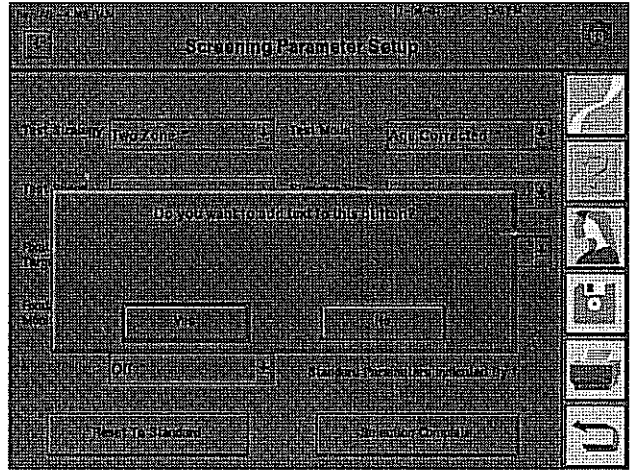

Examples of identifying remarks are "Blue-Yellow," "FastPac," or "Dr. Brown's Test." See Section 9: "Configuration Backup and Restore" for an example of a Main Menu screen displaying personalized test buttons with additional text.

Note: The Humphrey test pattern name (Central 24-2, G-40 Screening, etc.) cannot be altered.

8 Repeat this process for each button you wish to change.

Note: Buttons which have not been altered through the Alter Main Menu sequence will continue to use standard testing parameters. Testing parameters which are changed via the CHANGE PARAMETERS button during a particular test revert back to the parameters assigned to that button once that visual field test is completed, unless you select TEST OTHER EYE.

Deleting a button

1 Start at the System Setup screen. Select ALTER MAIN MENU.

2 Select DELETE A BUTTON.

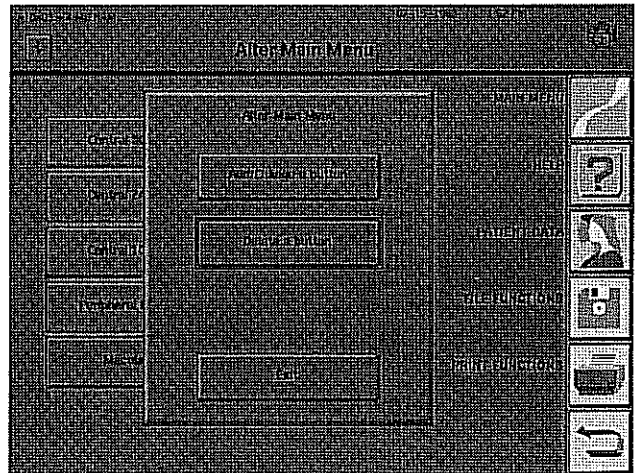

3 Choose the button you wish to remove.

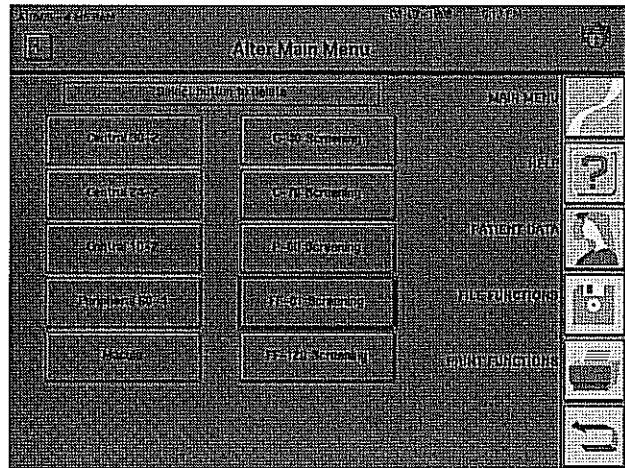

4 If you want to delete a button, press DELETE when prompted.

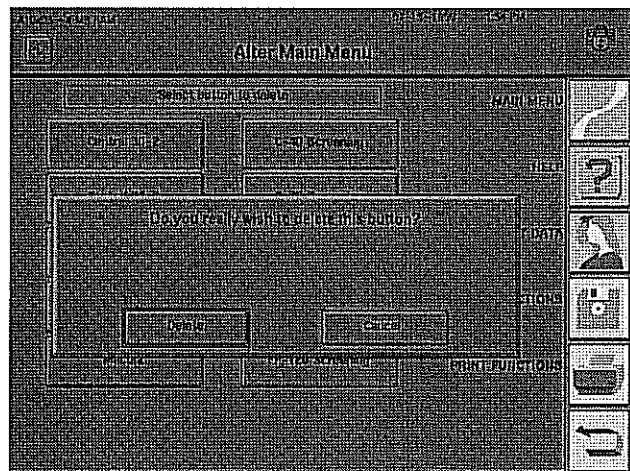

5 Deleted buttons will be marked "Test Position Now Blank" on the Alter Main Menu screen. They will appear blank on the Main Menu screen.

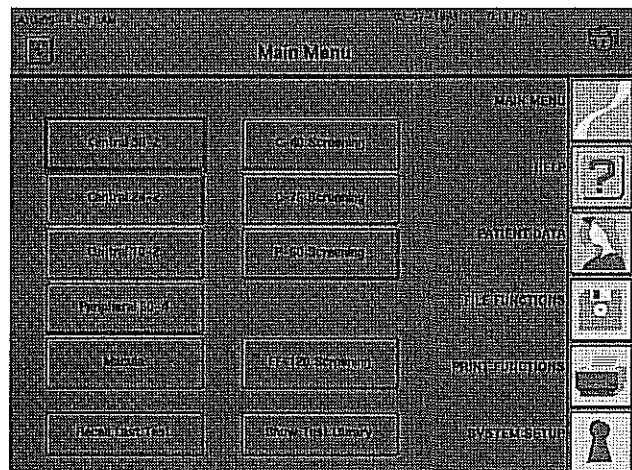

Note: Any test removed from the Main Menu screen can still be accessed through SHOW TEST LIBRARY. Standard parameters will be in effect when using a test from the test library unless CHANGE PARAMETERS is selected before testing is begun.

Adding text to an existing button

ADDITIONAL SETUP

There is no direct method for adding text to an existing button without going through the "Altering the Main Menu Screen" sequence described previously. Be sure to note the test type and parameters used on the existing button before selecting ADD/CHANGE A BUTTON. Designate the same test along with the same testing parameters. When the "Do you want to add text to this button?" dialog box appears, press YES.

The Additional Setup screen is accessed by pressing the ADDITIONAL SETUP button located on the lower right of the System Setup screen. Brief descriptions of the functions available on this screen are cited below.

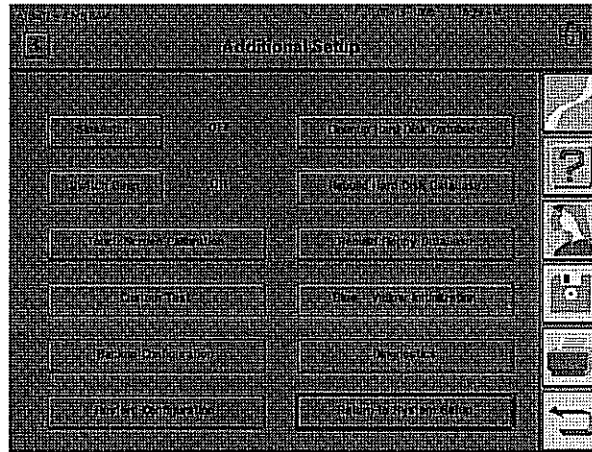

Figure 2.8: Additional Setup Screen



Simulation

This button is used to demonstrate and verify software function. Press the button to change between ON and OFF. If a test runs while simulation is ON, sample threshold data will appear on the screen in a matter of seconds. Turn simulation OFF before running any tests on patients. Simulation automatically turns OFF when the instrument is powered off.

Switch Beep

The patient response button is designed to give audio feedback every time the button is pressed. Press the SWITCH BEEP button to change between ON and OFF. SWITCH BEEP may be turned OFF prior to a test by pressing this button.

Touch Screen Calibration

Occasionally, pressing the touch screen will activate the button next to the one you intended to press. The touch screen alignment can be reset by pressing this button and following the instructions on the screen. See Section 12: "Touch Screen Calibration".

Custom Test

This button brings you the Custom Test Options pop-up window. It allows you to create or delete a Custom test pattern. For more information see Section 10: "Custom Testing" for more details.

Backup Configuration

Backup Configuration

You may save your customized Main Menu buttons (created with the "Altering the Main Menu" feature) and Custom test patterns on a floppy disk. This function protects the information in case of a hard disk problem. See Section 9: "To Backup Configurations".

Restore Configuration

Restore Configuration

This function allows you to restore the information that was saved using the BACKUP CONFIGURATION button. See Section 9: "To Restore Configurations" for details.

Caution: Restoring from a floppy disk will change the current Main Menu configuration. It also replaces all custom tests in the Custom test library.

Cleanup Hard Disk Database

Cleanup Hard Disk Database (models 735, 740, 745, 750)

This feature deletes files containing patient data with no associated test data. This can occur when patient data is entered, but the test is not saved. This can also happen when patient data is entered early in the day for convenience, but the patient does not take the visual field test. Pressing the CLEANUP HARD DISK DATABASE button will remove all the "unassociated" data from the database. See Section 9: "Cleanup Hard Disk Database" to utilize this feature.

Rebuild Hard Disk Database

Rebuild Hard Disk Database (models 735, 740, 745, 750)

The rebuild function is used in the event of a database failure. Rebuilding the patient database may take several hours to complete, depending upon the number of files present. It is best to perform this function at the end of a day or over a weekend. See Section 9: "Rebuild Hard Disk Database" for more information.

Rebuild Floppy Database

Rebuild Floppy Database

This allows the user to rebuild the database on a floppy disk. A full floppy disk may take several minutes to rebuild. See Section 9: "Rebuild Floppy Disk Database" for details.

Blue-Yellow Initialization

Blue-Yellow Initialization

This button was used for the one-time A6 software initialization procedure. You will not need to perform this initialization.

Diagnostics

Diagnostics

This feature is only accessed by Humphrey Service Technicians. It leads to a variety of tests used for system calibration and repair.

Return to System Setup

Return to System Setup

This button returns you to the main System Setup screen.

HELP SCREENS

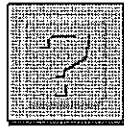

The HEA II is equipped with help screens to assist you with a number of topics concerning the instrument's operation. The *HELP* icon may be pressed at almost any time to access the on-screen Help menu. The *HELP* icon is not available when a pop-up window is displayed. You must complete the action within the pop-up window or cancel the action to access the Help menu. When pressing the *HELP* icon, the following Help Topics screen is displayed:

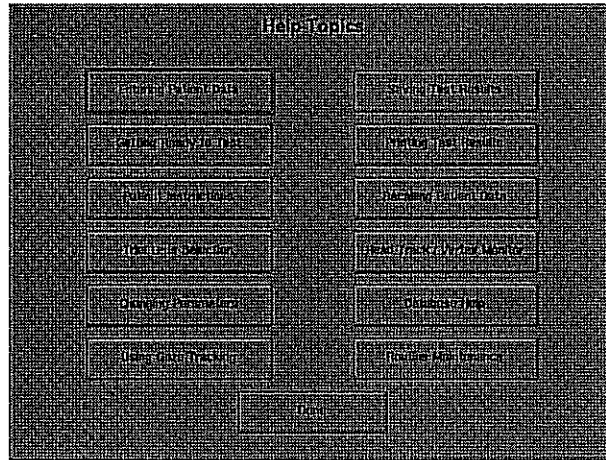

Figure 2.9: Help Topics Screen

Make your selection from a list of 12 topics. Topics that require more than one screen of information will have buttons at the bottom of the screen for advancing to the next screen (or for returning to the previous screen).

Each topic displayed may be printed by pressing the PRINT button at the bottom of the Help screen. The entire text of the subject being viewed will be printed. Topics requiring more than one screen, such as "Printing Test Results", will have the complete text printed, not just the screen being viewed.



Figure 2.10: Example of a Help Screen

When you have finished with the help topic, press RETURN to return to the Help Topics screen. Pressing DONE on the Help Topics screen will return you to the screen where you first pressed the *HELP* icon. For example, if you were at the "End of Test" screen when you originally pressed the *HELP* icon, you will return to the same "End of Test" screen when you press DONE on the Help Topics screen.

Consult the User's Guide for additional information on the subject of interest. The following is the list of on-screen Help topics and the main areas within this User's Guide to find additional information:

- Entering Patient Data – Section 3
- Getting Ready to Test – Section 3
- Patient Instructions – Section 3
- Trial Lens Selection – Section 3
- Changing Parameters – Section 4
- Using Gaze Tracking – Section 5
- Saving Test Results – Section 5
- Printing Test Results – Section 7
- Recalling Patient Data – Section 3
- Head Tracking/Vertex Monitor – Section 5
- Database Help – Section 9
- Routine Maintenance – Section 12

Setting-Up Tests

Selecting the Test Pattern and Test Eye	3-2
Entering Patient Data	3-8
Using Trial Lenses	3-19
Preparing the Patient	3-22

Pre-test activities are broken down into the steps listed above. This section covers each step in detail so that you can perform them all competently and efficiently.

Also included:

- a complete listing of available tests and their applications
- the proper use of trial lenses
- patient testing instructions
- hints on positioning the patient comfortably.

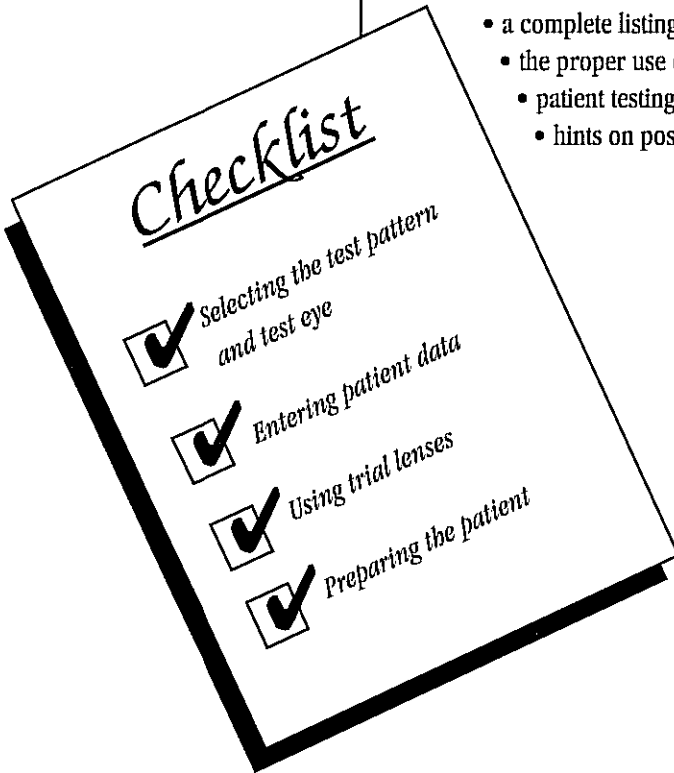

SELECTING THE TEST PATTERN AND TEST EYE

The Main Menu screen is the starting point for performing all tests. From here tests are selected using one of two methods:

- Using test buttons.
- Using the test library.

For details on each test, see "The Test Library". After a test is chosen, the user enters patient data, as described in "Entering Patient Data" later in this section.

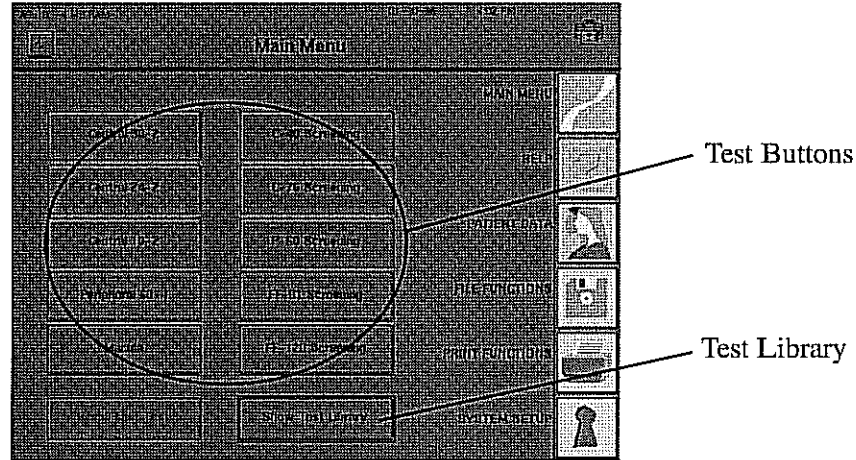
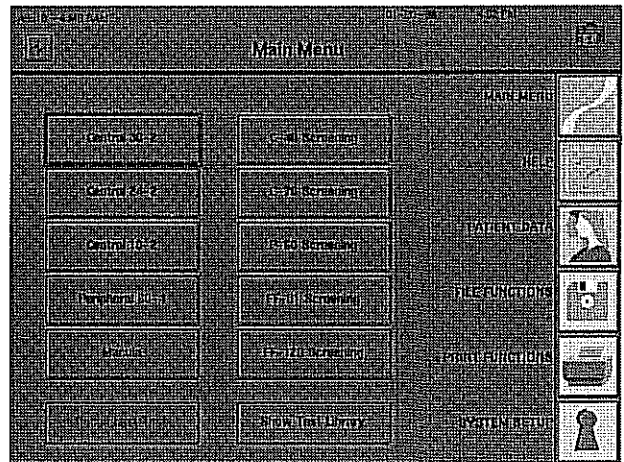

Figure 3.1: Selecting Tests from the Main Menu Screen

Using test buttons

Using Test Buttons is the most convenient method of selecting tests. Your new HFA II has test buttons that are preset with the most commonly used tests. They can be changed, however, to suit your clinical needs. See Section 2: "Altering the Main Menu Screen".

1 From the Main Menu screen, choose a test by pressing the test button.



2 Select the test eye. Choose RIGHT or LEFT to proceed, or CANCEL to go back to the Main Menu screen.

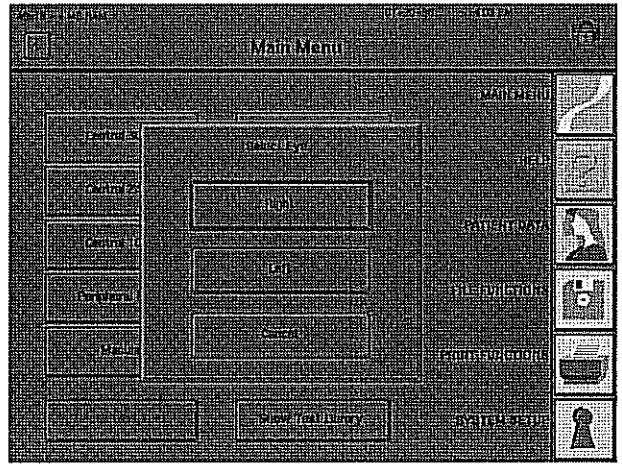

3 Refer to "Entering Patient Data," later in this section, to continue test setup.

Using the test library

Use this method to select a test that does not appear on one of the test buttons.

1 From the Main Menu screen, choose SHOW TEST LIBRARY.

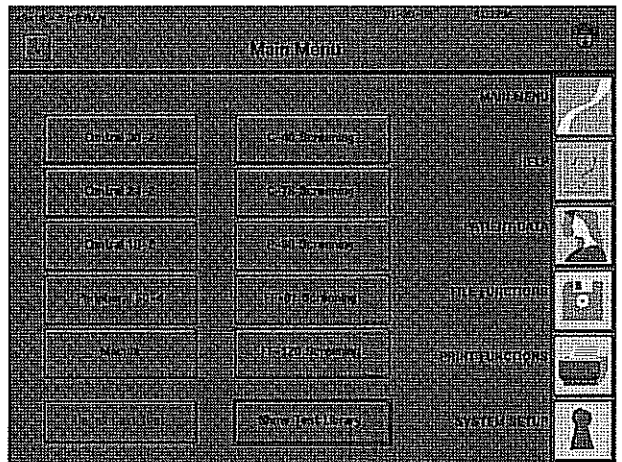

2 Select the test type. Choose from KINETIC, SCREENING, CUSTOM, THRESHOLD, or SPECIALTY.

In this example, SCREENING is chosen.

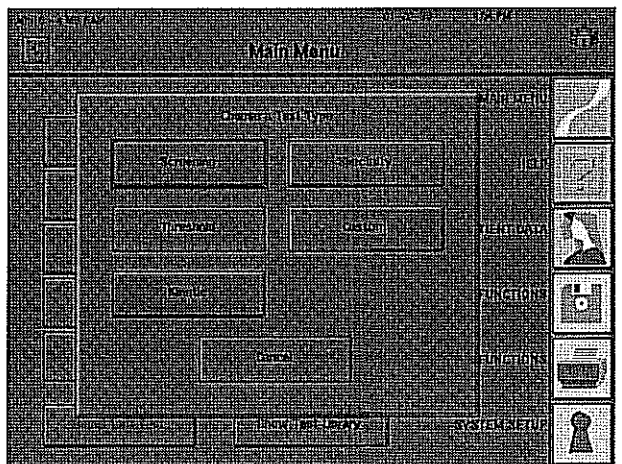

- 3** Select the test pattern.
Choose from among several test patterns.

Refer to "Test Library" below for information on each pattern.

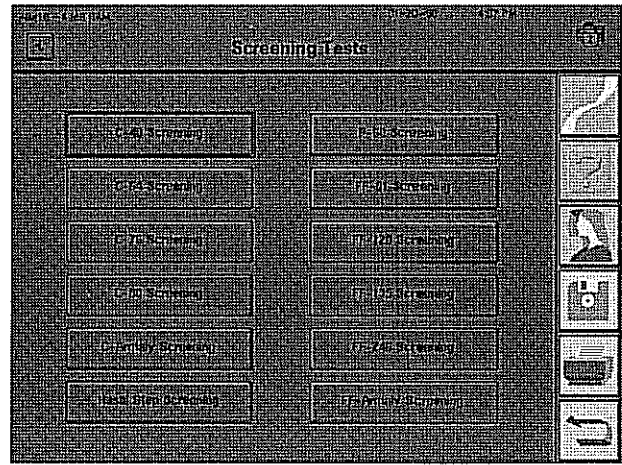

- 4** Select the test eye. Choose **RIGHT** or **LEFT** to proceed, or **CANCEL** to go back to the test library.

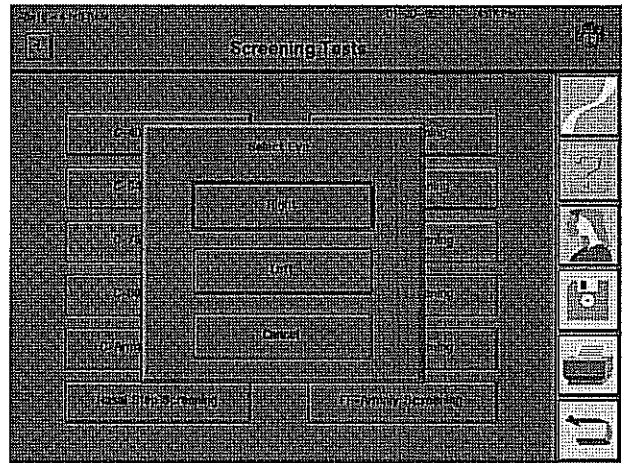

- 5** Refer to "Entering Patient Data", later in this section, to continue test setup.

Test library

The HFA II offers a variety of screening and threshold test patterns that meet most clinical needs. Tables 3.1, 3.2, and 3.3 describe each pattern in order to assist the professional in choosing the one best suited to the patient's needs. Appendix E contains diagrams of the available test patterns.

The HFA II model 750 offers Kinetic testing and all HFA II models except the 720 can perform Custom testing, but there are no preset patterns for these test types. See Section 10 (Custom) and Section 11 (Kinetic) for more information on these test types.

Screening tests serve an important clinical function by quickly surveying the visual field and flagging areas that are highly suspect. They answer the question, "Is there a problem?". Abnormal test results warrant further investigation with threshold testing.

Threshold tests more precisely define the problem by calculating the actual sensitivity level at each test point. They uncover early depressions and subtle changes in retinal sensitivity.

Specialty tests are specially designed screening tests for specific purposes. See Table 3.3 for details about the Specialty tests.

Table 3.1: The Screening Test Library

Screening Test Library	Extent of Visual Field Tested/Number of Points Tested	Application
Central 40	30 degrees/40 points	General screening
Central 64*	30 degrees/64 points	General, glaucoma, neurological
Central 76	30 degrees/76 points	General, glaucoma, neurological
Central 80	30 degrees/ 80 points	General Screening
Central Armaly*	30 degrees/84 points	Glaucoma
Peripheral 60	30 to 60 degrees/ 60 points	General, neurological with central exam, retinal, glaucoma
Nasal Step*	50 degrees/14 points	Glaucoma
Armaly Full Field*	50 degrees/98 points	Glaucoma
Full Field 81	55 degrees/81 points	General, retinal, glaucoma, neurological
Full Field 120	55 degrees/120 points	General, retinal, glaucoma, neurological
Full Field 135*	87 degrees/135 points 87 degrees temporally	Full Field Screening,
Full Field 246*	60 degrees/246 points	Full Field Screening

* not available on model 720

Table 3.2: The Threshold Test Library

Threshold Test Library	Extent of Visual Field Tested/Number of Points Tested	Application
10-2	10 degrees/68 point grid	Macula, retinal, neurological, advanced glaucoma
24-2	24 degrees/54 point grid	Glaucoma, general, neurological
30-2	30 degrees/76 point grid	Glaucoma, retinal, neurological, general
60-4	30 to 60 degrees/60 points	Retinal, glaucoma
Nasal Step*	50 degrees/14 points	Glaucoma
Macula*	5 degrees/16 points, 2 degree spacing	Macula

* not available on Model 720

Table 3.3: The Specialty Test Library

Specialty Test Library	Extent of Visual Field Tested/Number of Points Tested	Application
Esterman Monocular	75 degrees temporal 60 degrees nasal/100 points	Functional disability
Esterman Binocular	150 degrees bitemporal/ 120 points	Functional disability
Superior 36*	60 degrees, superior hemifield/36 points	Superior Field Screening
Superior 64*	60 degrees, superior hemifield/64 points	Superior Field Screening

* uses the Bottom LED fixation target

Test library notes:

- The Bottom LED fixation target is automatically used by the HEA II in order to test all points of the Superior 36 or Superior 64 point Screening Test. Remember to direct the patient's fixation to this lower target. If you manually set the Central target to be used with either Superior Field test, some of the most superior points will be omitted from the test pattern.
- The Full Field 135 Screening Test will not display all tested points on the screen. However, all points will be tested and may be viewed on the printout.
- To better view the central portion of any completed Full Field test, use the ZOOM button located on the End of Test or View Test screen.
- Any Full Field test whose central 30 degrees have been tested, may be saved, printed and later recalled from disk without completing the peripheral portion of the test.
- The Central 76 point test grid is identical to that of the 30-2 Central threshold test. This allows the practitioner to follow up screening tests with threshold testing at the same points. Similarly, the Peripheral 60 screening test has the same test pattern as the 60-4 threshold test.
- The Macula Threshold Test will test all 16 points twice if the Fluctuation feature is turned ON. If it is turned OFF, the Macula Threshold Test will determine the threshold once. With Fluctuation OFF, the instrument will determine the macular threshold twice only if there is a discrepancy with expected values. The Fluctuation function may be accessed through the Change Parameters menu screen. See Section 6: "Fluctuation Values" or Section 7: "Global Indices" for further information.
- The Esterman test scores are based on the percent of seen test points; 100 points for monocular tests and 120 for binocular tests. The HEA II automatically determines the functional score as a percentage which is printed on the lower right corner of the printout. The test incorporates the single intensity strategy and uses a 10 dB stimulus. This value has been standardized by international agreement and may not be altered by the user.
- Humphrey Systems is grateful to the American Academy of Ophthalmology for providing the rights to offer the Esterman test for your use.

ENTERING PATIENT DATA

Once you have selected the test and test eye, you will be ready to input patient data. You can input a variety of information about your patient each time he or she takes a visual field test. You need not enter all information requested; however, always enter a name and date of birth since they are required for trial lens calculations, data analysis, and saving the test to the hard drive or to floppy disk.

The patient data section is divided into two main screens: Patient Data 1 displays demographic and trial lens information; Patient Data 2 displays diagnostic information.

Inputting patient ID, patient name, date of birth, & comments

1 From the Patient Data 1 screen, choose PATIENT ID.

This Patient ID option allows the user to create a custom method of cataloging patients.

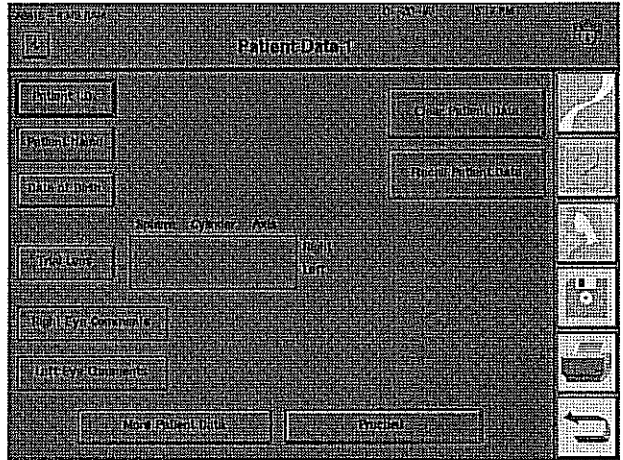

2 Input up to 11 characters from the pop-up keyboard.

Press ENTER.

You will automatically be returned to the Patient Data 1 screen.

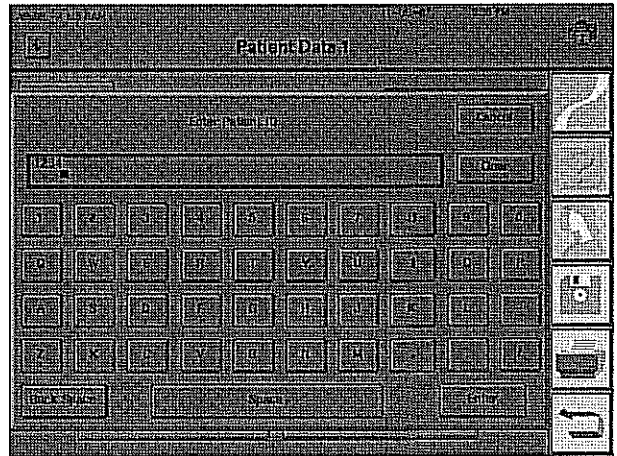

3 From the Patient Data 1 screen, choose PATIENT NAME.

4 Input up to 23 characters from the pop-up keyboard.

Press ENTER.

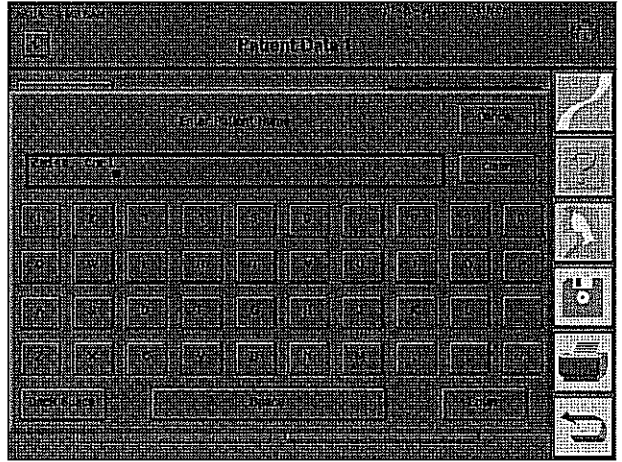

Note: The HFA II will recognize two tests as belonging to the same patient as long as the first and last names have identical spelling and the dates of birth match. The addition of spaces and/or commas to the names, even if different between entries, does not prevent the HFA II from recognizing these names as identical.

For example, these entries are all handled the same way:

- “Kennedy, Robin” is the same as
- “Kennedy ,Robin” or
- “Kennedy Robin”.

5 Choose DATE OF BIRTH.

6 Input the Month, Day, and Year from the pop-up keypad, including dashes (-) between entries.

You may enter the year as either two digits or all 4 numbers. The year will be displayed in the 4 digit format.

Press ENTER.

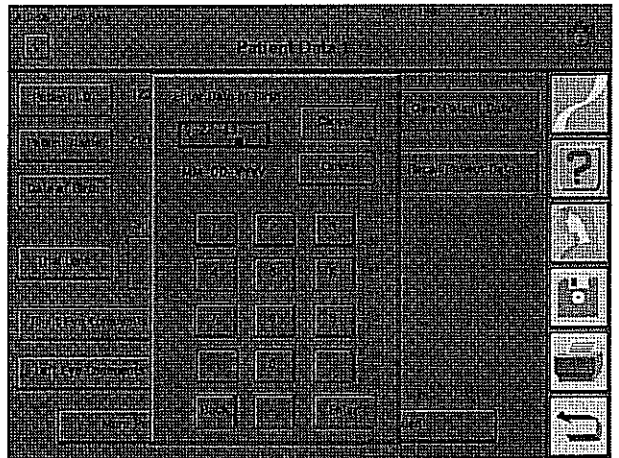

Note: September 22, 1943 should be entered as 9-22-43. The patient is assumed to be less than 100 years old if you enter the year as a two digit number. Your HFA II is Year 2000 (Y2K) compliant.

7 Choose RIGHT EYE COMMENTS.

8 Input up to 2 lines of text from the keyboard.

Press ENTER.

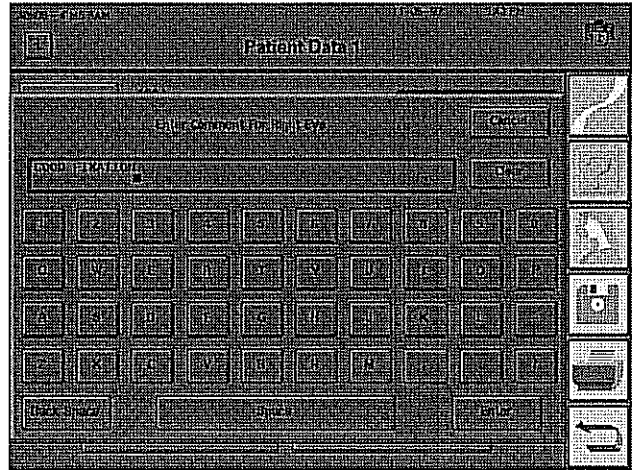

9 Repeat Steps 7-8 for LEFT EYE COMMENTS. Comments appear on the test results printout.

Inputting trial lens data

Many people with a refractive error will need to use trial lenses in order to accurately perform central field tests or the central portion of Full Field tests. The HEA II will automatically calculate the proper trial lens prescriptions for the patient, or you can manually input any other trial lens selection. For whichever method chosen, the trial lens data will be stored on the Patient Data 1 screen.

Refer to the appropriate section below:

- Automatic Trial Lens Calculation
- Manual Trial Lens Input

AUTOMATIC TRIAL LENS CALCULATION:

1 From the Patient Data 1 screen, select TRIAL LENS.

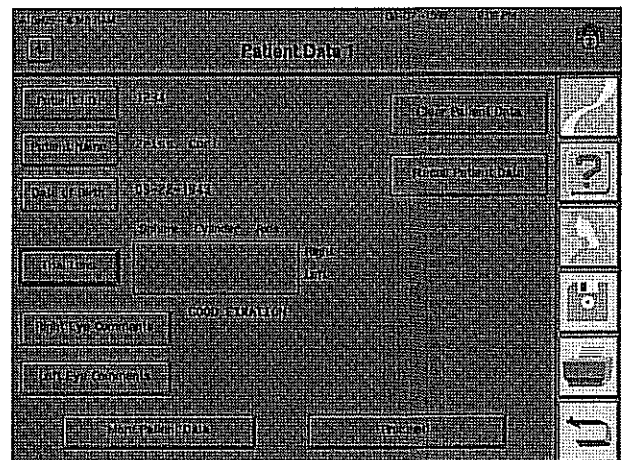

2 Choose CALCULATE TRIAL LENS.

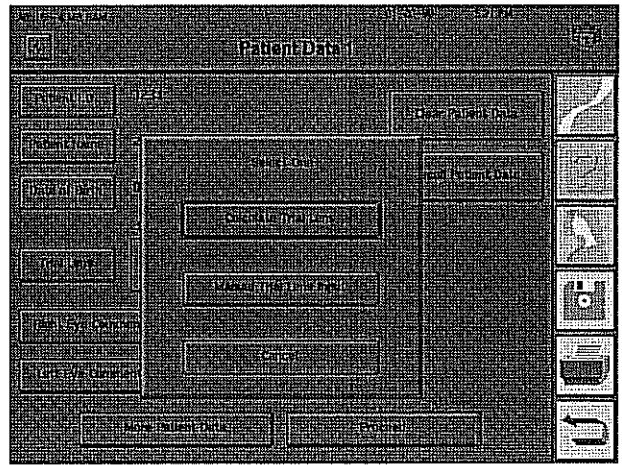

3 For the right eye, select SPHERE.

If you have not entered the patient's date of birth, enter it at this screen by pressing DATE OF BIRTH. The trial lens cannot be calculated without this patient information.

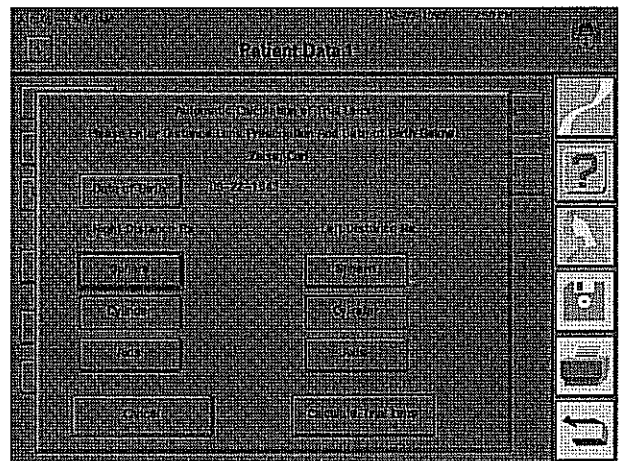

4 Input the patient's distance sphere correction. Always remember to enter a plus (+) or minus (-) as the first character. Press ENTER.

If the patient has no sphere correction (plano), you must enter zero (0) for the proper trial lens calculation to be made.

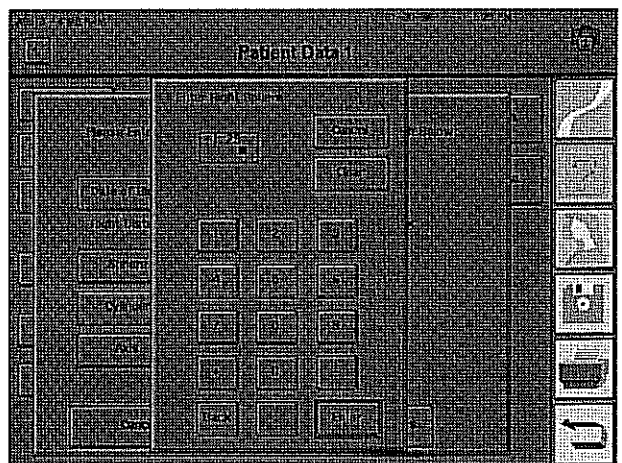

5 Enter correction for cylinder and axis, if needed.

- 6 Repeat Steps 4-5 for the left eye.

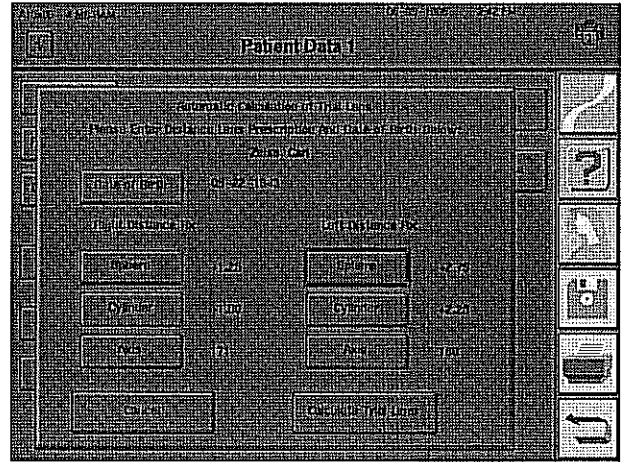

Note: SPHERE, CYLINDER, and AXIS may be chosen in any sequence. To correct entries, re-select the command button and then enter the correct data.

- 7 Select CALCULATE TRIAL LENS.

- 8 The trial lens data is automatically entered on the Patient Data 1 screen.

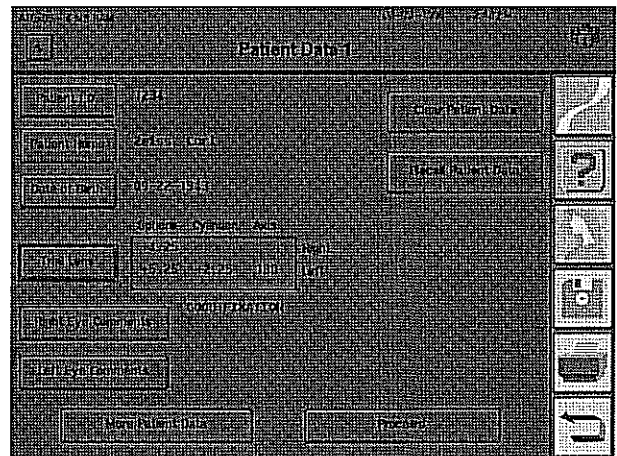

FOR MANUAL TRIAL LENS INPUT:

1. From the Patient Data 1 screen, select TRIAL LENS.
2. Choose MANUAL TRIAL LENS INPUT.
3. Repeat Steps 3-6 above.
4. Choose ENTRY COMPLETE. The manually entered trial lens data is automatically entered on Patient Data 1.

Note: For guidelines on selecting the proper trial lens (for manual input), refer to "Using Trial Lenses" and Table 3.4.

Clearing patient data

Often you will want to enter information for a new patient on a blank Patient Data screen. To remove all information on the Patient Data 1 and Patient Data 2 screens, use CLEAR PATIENT DATA.

1 From the Patient Data 1 screen, choose CLEAR PATIENT DATA.

2 Read the confirmation question and answer appropriately.

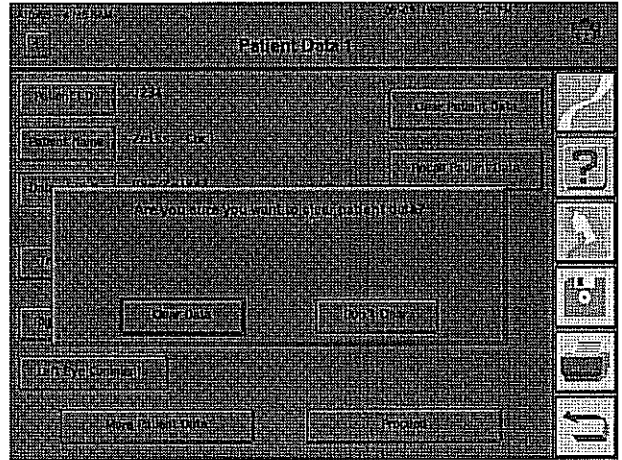

Note: Clearing Patient Data only deletes information from the screen. It does not delete information from the database if the patient data was previously saved.

Recalling patient data

When patients return for follow-up testing, you save time and ensure consistency by recalling previously entered patient data from stored files.

1 From the Patient Data 1 screen, choose RECALL PATIENT DATA to automatically transfer patient information from memory to the patient data screen(s).

2 Select the Source (HARD DRIVE or FLOPPY).

Choose PROCEED.

3 The keyboard appears. Type a few letters of the name you wish to find.

Press ENTER.

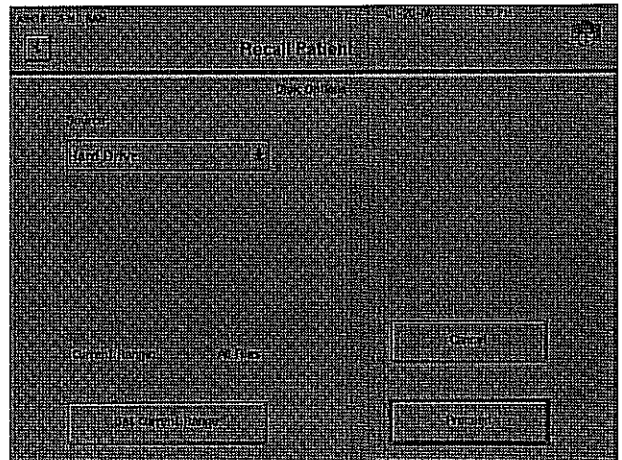

4 Choose the patient file you want to retrieve. Use scroll arrow buttons, if necessary, to locate the file (see below). Press PROCEED.

If you see two files that belong to the same patient and you wish to combine them, you may use the MERGE PATIENTS button. See Section 8: "Merging Patient Files" for details.

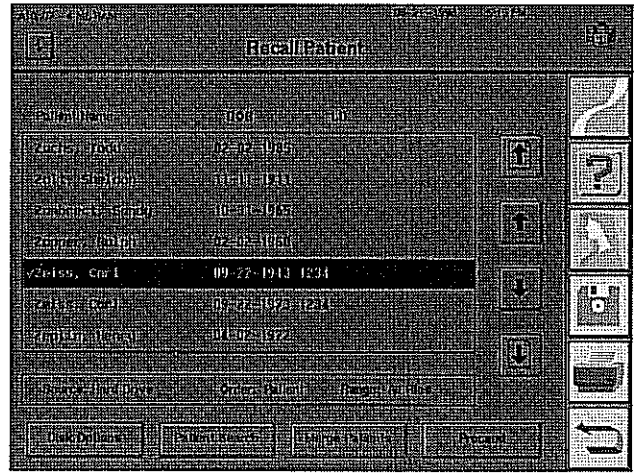

The "Page Up Arrow" scrolls up a full screen of patients.

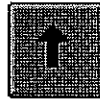

The "One Up Arrow" scrolls up one patient.

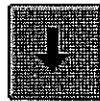

The "One Down Arrow" scrolls down one patient.



The "Page Down Arrow" scrolls down a full screen of patients.

To quickly locate a patient's test, access the PATIENT SEARCH button below the File Directory box. Enter the patient's name in the ENTER NAME TO FIND screen and press PROCEED. The HFA II will search the database for that patient's tests. If the name cannot be found, the name which follows alphabetically will appear. The PATIENT SEARCH command regards names with multiple spaces or different punctuation as identical.

5 Edit patient information, as necessary.

Choose MORE PATIENT DATA to verify, change or add data on the Patient Data 2 screen.

Choose PROCEED to go to the test screen.

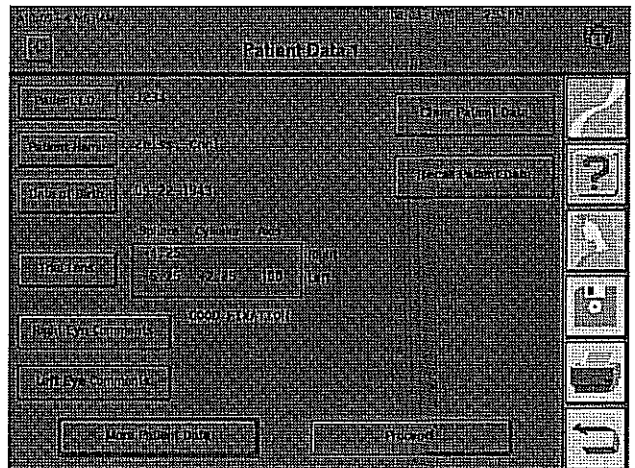

Patient data 2 screen

The Patient Data 2 screen contains diagnostic data fields. When using the external keyboard to enter data, press the TAB key to move to the next data field. The values entered for visual acuity and pupil diameter will also appear on the printout with the test results.

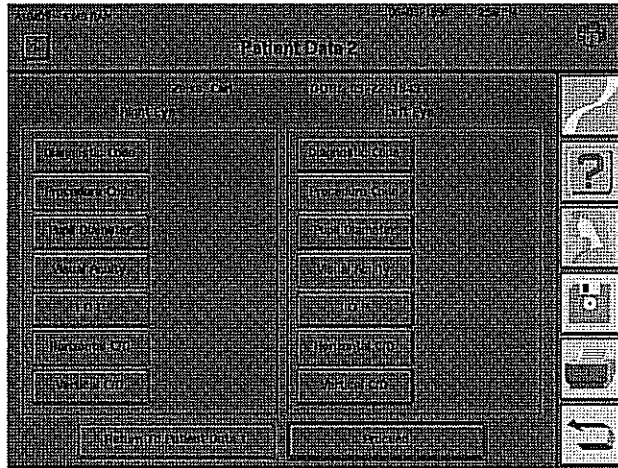
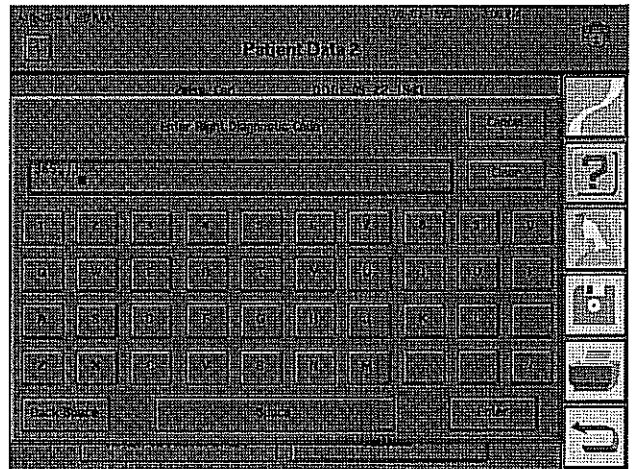

Figure 3.3: The Patient Data 2 Screen

Inputting diagnostic and procedure codes

1 From the Patient Data 2 screen, choose DIAGNOSTIC CODE.

2 Input up to 14 characters from the pop-up keyboard, then ENTER.



3 Repeat Steps 1-2 for the other eye.

4 From the Patient Data 2 screen, choose PROCEDURE CODE.

5 Enter up to 14 characters from the pop-up keyboard, then ENTER.

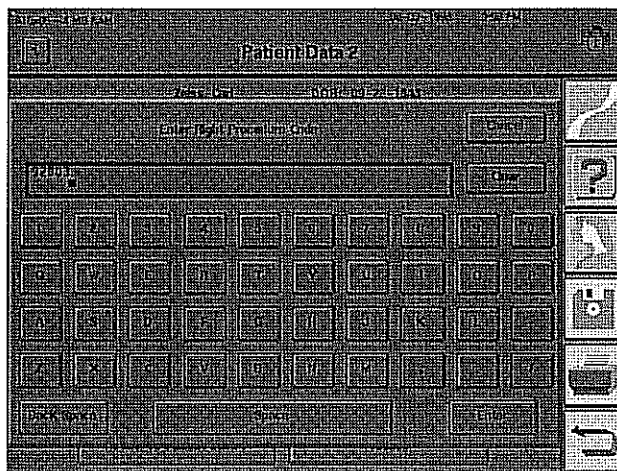

6 Repeat Steps 4-5 for the other eye.

Inputting pupil diameter and visual acuity

1 From the Patient Data 2 screen, choose PUPIL DIAMETER.

2 Enter up to 4 characters (0-14.5; decimal point counts as one character) from the pop-up keypad, then ENTER.

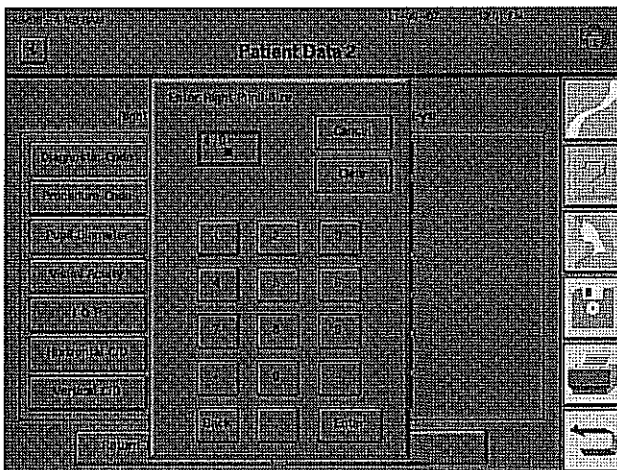

3 Repeat Steps 1-2 for the other eye. The pupil diameter value will also appear on the printout.

Note: If the Autopupil feature (model 750 only) is being used, you need not enter a pupil diameter. The automatic pupil measurement will be entered and noted with an asterisk () on the Patient Data 2 screen. Gaze Tracking must be initialized for Autopupil to work.*

4 From the Patient Data 2 screen, choose VISUAL ACUITY.

Entering Cup/Disk (C/D) ratios

1 From the Patient Data 2 screen, choose HORIZONTAL C/D (cup/disk ratio).

2 Enter a decimal point and up to 2 characters (.00-.99) from the pop-up keypad, then ENTER.

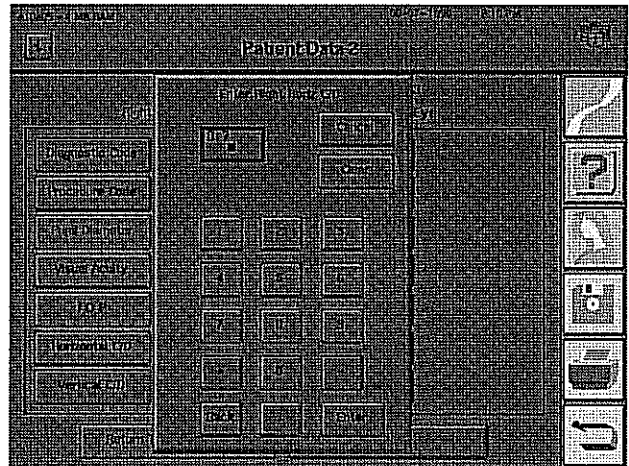

3 Repeat for the other eye.

4 Repeat Steps 1-3 for Vertical C/D.

When you have finished entering data on Patient Data 2 screen and are ready to test, choose PROCEED. This takes you to the test screen where you can set test parameters, if desired, before beginning the test (see Section 4).

Here is an example of a Patient Data 2 screen with a number of completed data fields. Remember, completing every field is not required for each patient. Refer to "Entering Patient Data".

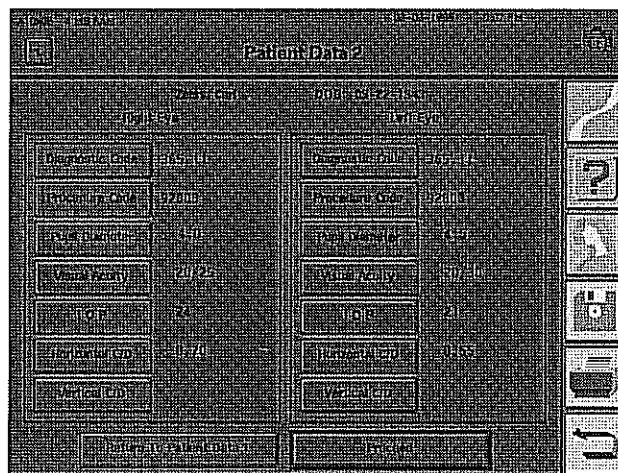

Figure 3.4: A Completed Patient Data 2 Screen

USING TRIAL LENSES

All patients requiring near vision correction should use trial lenses while taking **central field tests** and the **central portion of full field tests**. For your convenience, the HFA II automatically calculates the proper trial lens for your patient, if you know the patient's distance prescription and date of birth (refer to "Entering Patient Data" earlier in this section).

If you are not using the automatic trial lens calculation, refer to the following guidelines for selecting trial lenses.

GUIDELINES FOR TRIAL LENS SELECTION:

1. Ignore cylinders of 0.25 D or less.
2. For cylinder errors up to 1.25 D use the spherical equivalent. Use the full cylinder correction for cylinder errors of 1.50 D or more.
3. Refer to Table 3.4 to determine the spherical power to be used.

Table 3.4: Spherical Trial Lens Correction for Central Visual Field Testing

Age	Distance Rx Greater than Zero	Distance Rx Equals Zero (Plano)	-0.50	-1.00	-1.50	-2.00	-2.50	-3.00	> -3.00
	Spherical Trial Lens to Be Used								
	Use Hyperopic								Myopic
Under 30	Distance Rx	•	•	•	•	•	•	•	Dist. Rx + 3.25
30 to 39	Dist. Rx + 1.00	+1.00	+0.50	•	•	•	•	•	Dist. Rx + 3.25
40 to 44	Dist. Rx + 1.50	+1.50	+1.00	+0.50	•	•	•	•	Dist. Rx + 3.25
45 to 49	Dist. Rx + 2.00	+2.00	+1.50	+1.00	+0.50	•	•	•	Dist. Rx + 3.25
50 to 54	Dist. Rx + 2.50	+2.50	+2.00	+1.50	+1.00	+0.50	•	•	Dist. Rx + 3.25
55 to 59	Dist. Rx + 3.00	+3.00	+2.50	+2.00	+1.50	+1.00	+0.50	•	Dist. Rx + 3.25
60 and over	Dist. Rx + 3.25	+3.25	+2.75	+2.25	+1.75	+1.25	+0.75	•	Dist. Rx + 3.25

• means no spherical trial lens needed

Remember, you only need to use a trial lens when testing the central part of the patient's visual field. The trial lens must be removed for the peripheral portion of any Full Field test. A trial lens is not used for either Superior Field screening test or any Peripheral threshold or screening test. The following are examples of trial lens corrections using Table 3.4:

Example A.

For an emmetropic (plano) 70 year-old patient, follow the Distance Rx Equals Zero (Plano) column to the 60 & Over row. The trial lens correction for this patient is +3.25 D.

Example B.

For the 61 year-old patient with a distance refraction of +1.50 +0.50 X 60, first calculate the spherical equivalent (+1.75). Then follow the Distance Rx Greater than Zero column to the 60 & Over row where you are instructed to add +3.25 to the distance Rx of +1.75. The trial lens correction for this patient is +5.00 D.

Example C.

For the 35 year-old patient with a distance refraction of +2.00 +1.50 X 90, use a +1.50 D cylinder lens and rotate the axis to 90 in the trial lens holder. Follow the Distance Rx Greater than Zero column to the 30-39 row where you are instructed to add +1.00 to the distance Rx of +2.00. The trial lens correction for this patient is +3.00 +1.50 X 90.

Example D.

For the 30 year-old patient with a distance refraction of -3.00 +0.25 X 90, the 0.25 cylinder is ignored. Follow the -3.00 column to the Age 30-39 row. The • signifies that this patient does not need a trial lens correction, as the bowl will be in focus with no correction whatsoever.

Example E.

For the 63 year-old patient with a distance refraction of -3.00 +2.00 X 75, use a +2.00 cylinder lens and rotate the axis to 75 in the trial lens holder. Follow the -3.00 sphere column to the 60 & Over row. The • indicates that the patient does not require a spherical correction. Use only the cylinder trial lens correction.

Example F.

A 25 year-old patient with a distance refraction of -4.00. Follow the > -3.00 column to the Under 30 row where you are instructed to add +3.25 to the distance Rx. The correct trial lens is -0.75.

Note: If your patient is aphakic or needs a high refractive power such as +8.00 D, contact lenses may provide the best visual field testing conditions.

Inserting trial lenses into the holder

1 Move the trial lens holder into an upright position from its storage position in the bottom of the bowl.

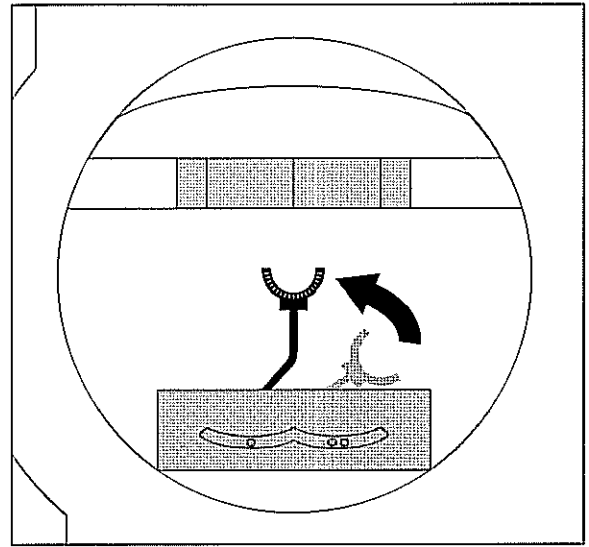

2 Place the cylinder lens in the slot farthest away from the patient and align the axis.

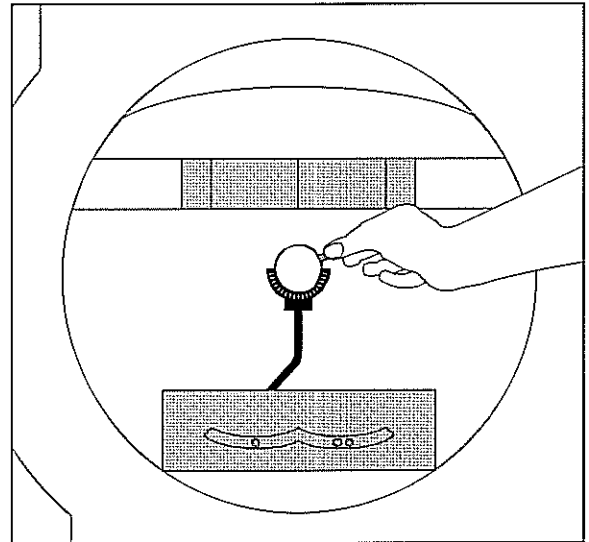

3 Place the sphere lens in the slot closest to the patient.

Note: Use only the narrow-rimmed type of trial lenses. The wide-rimmed variety will interfere with the patient's peripheral vision and affect test results. It is helpful to move the lens handle towards the patient's temporal side so it does not interfere with the patient's eye brow or nose.

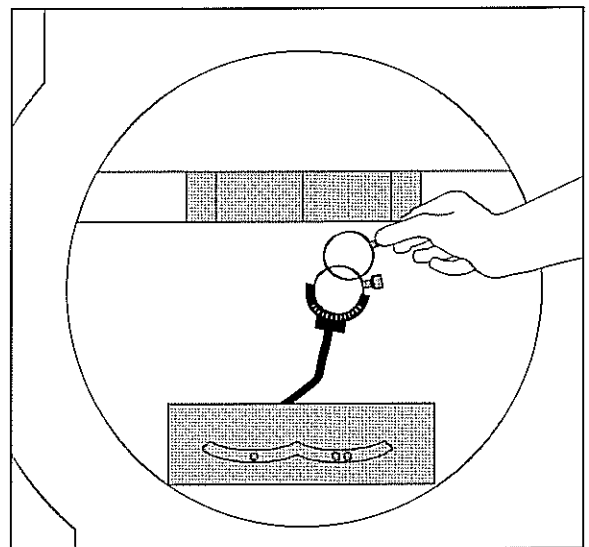

PREPARING THE PATIENT

Patient instructions for static testing

How well your patient understands the test procedure and how comfortable he or she is while taking the test directly influence the reliability of the test results.

Explain the test procedure clearly and completely. Answer all patient questions before starting. Use the following patient instructions as a guide, but remember to tailor your instructions to the patient's individual needs.

"This test will measure your central and side vision. It is important that you always look straight ahead at the steady yellow light (Point to yellow fixation light). Other lights will flash one at a time off to the side. Some will be bright, some dim. Press the button whenever you see one of these lights (Give patient the response button). You are not expected to see all of them." (For threshold tests: "The test is designed so that you may see fewer than half of them.")

"If you want to rest, hold down on the button (demonstrate to patient). The test will resume when you release the button. We test one eye at a time. Blink normally so your eye does not get dry. A good time to blink is whenever you push the response button."

Note: Instructions for Kinetic Testing differ slightly. See Section 11 for details.

Occluding the non-test eye

Position the eye patch over the non-test eye so that it completely blocks vision, as shown in the illustration. Make sure nothing interferes with the vision of the test eye. For example, if the patch is secured with an elastic band, position the band above the eyebrow of the test eye as shown.

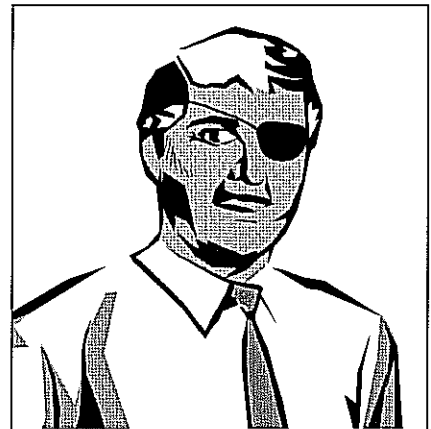

Seating the patient

To increase test reliability, take all steps necessary to ensure patient comfort:

- Adjust the table height.
- Adjust the seat height.
- Slide the instrument towards the patient.
- Check that the patient is relaxed and holding the response button.

Positioning the patient at the instrument

To facilitate patient positioning, the chin rest is divided into two cups, one designated for right eye testing the other for left eye testing.

Place patient's chin here when testing the right eye

Place patient's chin here when testing the left eye

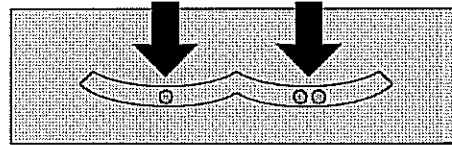

1 Instruct the patient to place his or her chin on the appropriate side of the chin rest, then assist with bringing the forehead against the forehead rest.

Adjust the table height to be as high as necessary to keep the patient sitting comfortably erect, rather than bent over or leaning forward.

Pull the slider handle out to release the slider. Slide the HFA II toward the patient to allow improved posture for the test. Release the handle to lock the slider in place.

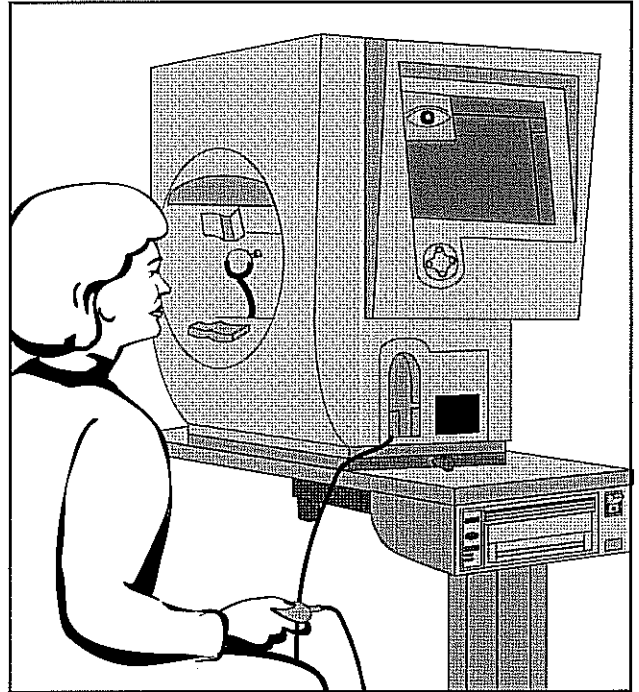

2 Align the patient on the video eye monitor so that the pupil is centered in the target. Press the chin rest control in the direction you want the patient's eye to move in the video eye monitor.

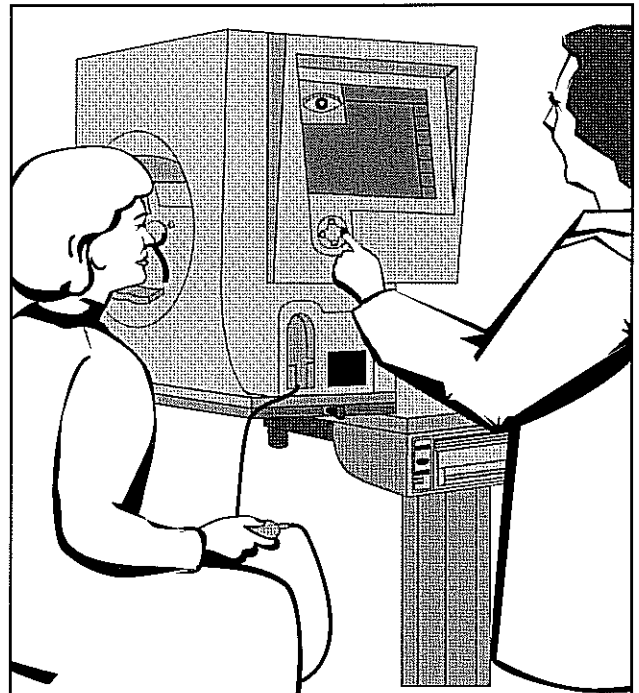

3 Move the trial lens as close to the patient's eye as possible without touching the lashes.

If you are running a Blue-Yellow test, the visor beneath the forehead rest must be extended. You should also allow the patient to adapt to the yellow bowl for about 3 minutes before testing. See Section 4: Blue-Yellow Testing" for details.



4 Review the patient's position in the video eye monitor. The cross (+) should be in the center of the pupil. Adjust as necessary.



When the patient has been properly instructed and comfortably positioned, you are ready to begin testing.

No trial lenses for Esterman monocular/binocular tests

This test is used to assess the level of a patient's functional visual disability. The Esterman tests are designed to be done using a patient's everyday correction. If the patient does not require glasses to function normally, perform the test without correction. If the patient does wear glasses to function normally, perform the monocular or binocular test using the patient's glasses. **Do not use trial lenses.** You still must use the eye patch when testing with the Monocular version of the Esterman test.

Setting Test Parameters	4-2
Test Strategies	4-4
SITA™ Testing	4-10
Blue-Yellow (SWAP) Perimetry	4-11
Alternate Color Testing	4-16

Your Humphrey Field Analyzer II has a number of options for using different parameters and testing strategies. The first part of this section discusses standard and non-standard testing parameters as well as the procedure to modify the parameters for specific patients.

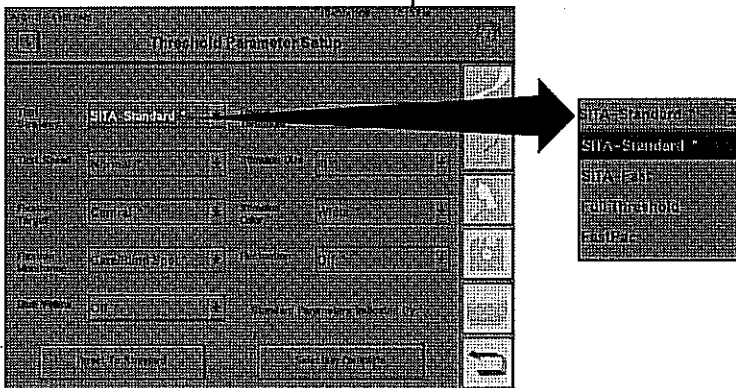

The second portion of this section discusses Blue-Yellow perimetry or SWAP (Short-Wavelength Automated Perimetry) and SITA (Swedish Interactive Thresholding Algorithm), two testing methods developed by Humphrey Systems in cooperation with leading authorities.

This section answers these and other questions:

- What test parameters can I change during the test?
- Can I slow down the test for an elderly patient?
- What are SWAP and SITA?
- Why is the Size V stimulus used for Blue-Yellow testing?
- When can the SITA testing strategy be used?

SETTING TEST PARAMETERS

Test parameters are the testing conditions used during a test, e.g. stimulus size, test strategy, test speed, etc. While the majority of patients are best examined using "standard" parameters (or default parameters), you can alter the parameter settings for purposes of tailoring the test to meet particular patient needs.

An example of a test parameter is the fixation target which has four settings: central, small diamond, large diamond, and bottom LED. The central fixation light is the default target. It is suitable for most patients, but you can change it if the patient requires a larger target.

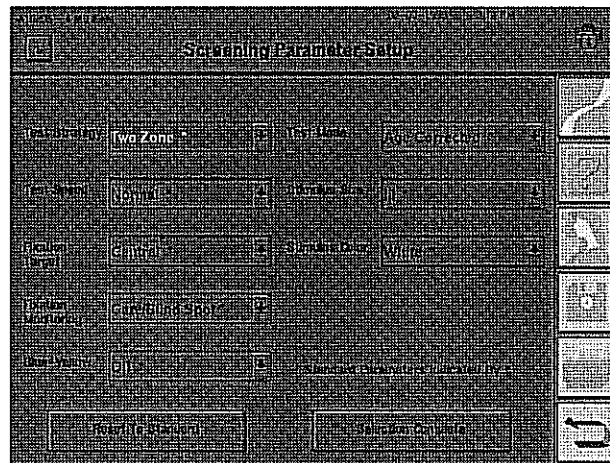

Figure 4.1: The Screening Test Parameter Setup Screen

To change test parameters

You can access the parameter setup screens two ways:

- From the Start Test screen via CHANGE PARAMETERS.
- From the Test in Progress and Pause screens; during testing only test speed and fixation monitoring can be changed.

1 Start at the Parameter Setup screen (Screening or Threshold). Select the parameter you wish to change.

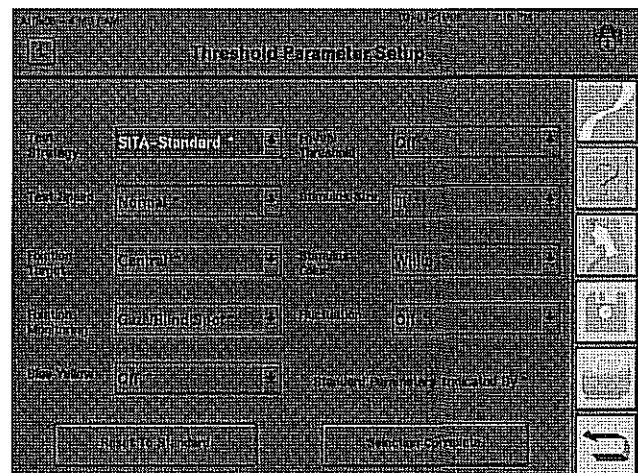

2 Select the parameter setting. The current setting is highlighted.

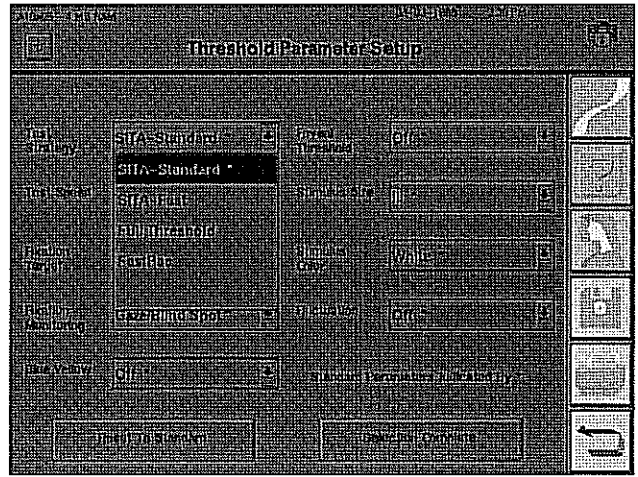

3 Repeat steps 1-2 for other parameters, then press SELECTION COMPLETE.

Standard parameters

One setting for each parameter has been designated as the "standard" setting. It is distinguished from the others by the appearance of an asterisk (*) on the parameter button. If you want to return all settings to the standard mode, select RESET TO STANDARD.

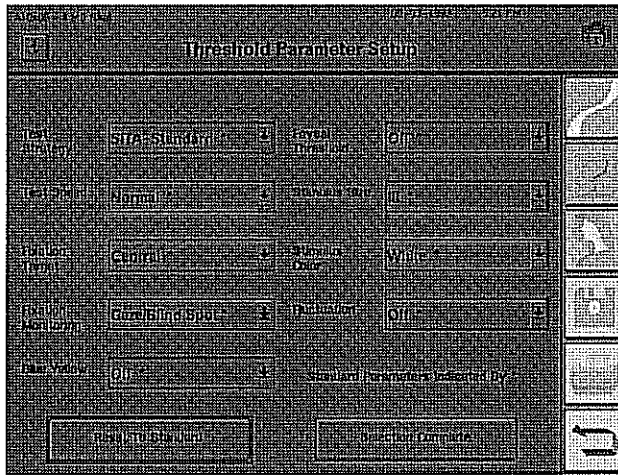

Note: For the purpose of valid comparison, it is important to keep test parameters consistent among different test visits for the same patient. This will maintain proper comparability when evaluating test results from many visits. Other than test speed and fixation monitoring, test parameters cannot be changed once testing has begun.

TEST STRATEGIES

One of the most important test parameter settings is strategy. For both screening and threshold testing, the strategy can affect the total test time and the precision to which the measurements are made. The strategy also dictates whether screening test results are displayed as qualitative (symbols) or quantitative (decibels) information. All threshold strategies yield quantitative results. Each measures the threshold at every test point. They differ only in the method used. Refer to Tables 4.1 and 4.2 for a more detailed explanation of screening and threshold parameters, respectively.

Table 4.1: Screening Test Parameters

(Standard parameter settings appear in **bold print**)

Screening Parameters	Parameter Settings	Description
Test Strategy	Two Zone	For each point in the test pattern, a stimulus is presented 6 dB brighter than the expected hill of vision. Printouts display circles (O) for seen stimuli and boxes (■) for missed stimuli. Since screening is done with an intensity 6 dB brighter than expected threshold, missed points are known to be at least 6 dB deep.
	Three Zone	Same as Two Zone, except each missed point is measured again at maximum intensity of 10,000 apostilbs (0 decibels) to determine if the defect is absolute. Printouts display circles (O) for seen stimuli, "X's" for relative defects, and boxes (■) for absolute defects.
	Quantify Defects	Same as Two Zone, except the sensitivity at each missed point is measured relative to the expected threshold. Printouts display circles (O) for seen stimuli, and numbers (in decibels) to indicate the depth of any defects. The greater the number, the lower the retinal sensitivity (deeper the defect).
Test Speed	Normal Slow	Two stimulus presentation speeds are available. The test speed may be changed while a test is in progress. The Normal setting automatically adjusts test speed for a slow responding patient.
Fixation Target	Central	Yellow light in the center of the bowl.
	Small Diamond	The Small Diamond is located below the Central target, and should be used when a patient cannot see the central fixation light (e.g. macular degeneration). The patient should look in the center of the diamond formed by the four lights.

Screening Parameters	Parameter Settings	Description
	Large Diamond	The Large Diamond is located below the Central target and is useful for patients with central scotoma who cannot see either the Central fixation light or the Small Diamond.
	Bottom LED	Some tests have points in the superior visual field that require a lower fixation light than the central target. The target used is the Bottom LED of the Large Diamond. When testing with the Superior 64 or Superior 36 Screening Speciality tests, the Bottom LED is the default fixation target. It is automatically illuminated at the start of a test.
Fixation Monitoring	Gaze/Blind Spot (models 740-750)	The Blind Spot and Gaze Monitoring system are both activated.
	Gaze Track (models 740-750)	The Gaze Track system automatically measures gaze direction at the time of stimulus presentation. Refer to Section 5: "Gaze Tracking" for more information.
	Blind Spot (Heijl-Krakau)	The test program periodically presents a stimulus in the patient's blind spot. If the patient is fixating well, he or she should not see the blind spot check stimulus. The Blind Spot check stimulus always matches the test stimulus size. Refer to Section 6: "Fixation Losses" for additional information.
	Off	Disables Gaze Track and Blind Spot fixation monitoring. The operator should monitor fixation with the video eye monitor.
Blue-Yellow	OFF/ON	<p>Models 745 and 750 allow Blue-Yellow testing. Blue-Yellow testing is performed using a Size V blue stimulus presented on a yellow background. Selecting the Blue-Yellow option will cause the system to default to these parameters.</p> <p>Because screening strategies have been designed and optimized for White-on-White testing, it is not recommended that screening tests be performed with the Blue-Yellow testing strategy.</p>

Screening Parameters	Parameter Settings	Description
Test Mode	Age Corrected	<p>A hill of vision is assigned to the patient based on the patient's age. The expected threshold at the hill's peak, the fovea, is called the central reference level. This central decibel value is indicated on the test screen and the printout.</p> <p>The patient's date of birth must be entered prior to beginning the test. Age corrected mode may only be used with standard stimulus size and color (Size III, White). If non-standard size and color parameters are selected with Age Corrected Screening, the instrument will default back to Threshold Related Strategy upon leaving the Change Parameter Screen.</p>
	Threshold Related	A hill of vision is assigned only after threshold values for 4 primary points are determined. The calculated threshold at the hill's peak, or fovea, is called the central reference level. This value appears on the test screen and the printout.
	Single Intensity	<p>The HFA uses a default intensity level of 10 dB to test the entire visual field. If a different intensity is desired, press CLEAR and enter the desired value on the keypad which appears. Press ENTER. The single intensity value will appear on the test screen (as Stim:) and on the printout as "Stimulus Intensity".</p> <p>Single Intensity levels may be set only in even increments.</p>
Stimulus Size	I, II, III, IV, V	Five stimulus sizes (diameters) are available on most instrument models. They range from Size I (smallest) to Size V (largest).
Stimulus Color	White	White stimulus projected onto bowl.
	Red	Red stimulus projected onto bowl.
	Blue	Blue stimulus projected onto bowl.

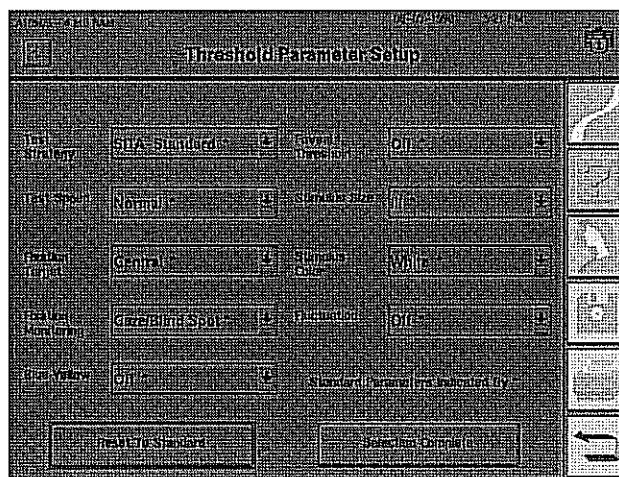

Figure 4.2: The Threshold Parameter Setup Screen

Table 4.2: Threshold Test Parameters

(Standard parameter settings appear in bold print)

Threshold Parameters	Parameter Settings	Description
Test Strategy	SITA-Standard™	This is the standard testing strategy for the Swedish Interactive Thresholding Algorithm (SITA). SITA-Standard cuts testing time in half relative to the Full Threshold strategy without compromising test reproducibility. See Appendix G for more details.
	SITA-Fast™	This is a faster version of SITA. SITA-Fast cuts testing time in half relative to the FastPac testing strategy without compromising test reproducibility. See Appendix G for more details.
	Full Threshold	A “bracketing” technique is used to threshold each test point. An initial stimulus is presented at a level the patient is expected to see. If seen, the stimulus intensity is decreased in 4 decibel steps (0.4 log units) until the patient no longer sees the stimulus; if not seen, it is increased in 4 dB steps until seen. The instrument then changes direction, moving in 2 dB steps until a change in patient response is made. The last stimulus seen by the patient is recognized as the threshold for that point.
		The bracketing process described above begins with 4 primary points whose threshold values are determined at the beginning of the test. The results at these points then influence the starting levels for neighboring points in the pattern.

Threshold Parameters	Parameter Settings	Description
	FastPac™	FastPac decreases Full Threshold test time by about 40%. It follows a similar stair-stepping technique as in Full Threshold, but uses 3 dB increments instead of 4 dB and crosses the threshold only once.
Test Speed	Normal	Same as Screening Parameters
	Slow	Same as Screening Parameters
Fixation Target	Central	Same as Screening Parameters
	Small Diamond	Same as Screening Parameters
	Large Diamond	Same as Screening Parameters
	Bottom LED	Some tests have points in the superior visual field which require a different fixation light than the Central target in order to expand the superior field range. The target used is the Bottom LED of the Large Diamond.
Fixation Monitoring	Gaze/Blind Spot (models 740-750)	Same as Screening Parameters
	Gaze Track (models 740-750)	Same as Screening Parameters
	Blind Spot	Same as Screening Parameters
	Off	Same as Screening Parameters
Blue-Yellow	OFF/ON	Models 745 and 750 allow Blue-Yellow testing. Blue-Yellow testing is performed using a Size V blue stimulus presented on a yellow background. Selecting the Blue-Yellow option will cause the system to default to these parameters. See "Blue-Yellow Testing" later in this section for more information.

Threshold Parameters	Parameter Settings	Description
Foveal Threshold	Off	A threshold value for the fovea will not be measured.
	On	<p>A threshold value for the fovea will be determined at the beginning of the test. The foveal threshold test presents stimuli inside the Small Diamond fixation target; the Small Diamond will automatically be illuminated.</p> <p>Refer to Section 5: "Foveal Threshold" for details on performing this supplemental test.</p>
Stimulus Size	I, II, III, IV, V	Same as Screening Parameters
Stimulus Color	White	Same as Screening Parameters
	Red	Same as Screening Parameters
	Blue	Same as Screening Parameters
Fluctuation	On	<p>Threshold values for ten (10) pre-selected points are retested to determine the variability of the patient's responses.</p> <p>Threshold values for the retested points are printed on the numeric printout and appear in parentheses directly below the first test result.</p> <p>Fluctuation values which differ significantly from normal are flagged with appropriate "p" (probability) values.</p>
	Off	<p>Threshold values for pre-selected points will not be determined twice. Some points may be retested even if fluctuation is off. Off is the default setting when Blue-Yellow is turned on.</p> <p><i>Note: Short-term Fluctuation (SF) and Corrected Pattern Standard Deviation (CPSD) values will not be available if fluctuation is off.</i></p>

SITA™ TESTING

Perimetry results are critical in the management of glaucoma and other eye diseases. Yet, obtaining useful results with existing protocols is often difficult to manage. Conventional threshold tests are often long and uncomfortable for patients. They tie-up staff and tire out patients, thus decreasing test reliability. The SITA testing strategy represents a major advance over the methods currently in use.

Humphrey Systems has developed two separate SITA testing strategies with two separate goals:

1. **SITA-Standard:** The goal was to design a perimetric thresholding method which collects twice as much information per unit time as the Humphrey Full Threshold standard algorithm. SITA-Standard cuts the test time in half without compromising test reproducibility relative to the current international standard.
2. **SITA-Fast:** The goal was to design a thresholding method which collects twice as much information per unit time as FastPac. SITA-Fast cuts the test time in half relative to FastPac, without compromising test reproducibility.

Tests available with SITA

Both SITA-Standard and SITA-Fast are designed to run with these threshold tests:

- Central 10-2
- Central 24-2
- Central 30-2
- Peripheral 60-4

SITA cannot be used with Blue-Yellow (SWAP) testing or for Custom tests.

All SITA tests must use a White, Size III stimulus. Any time a SITA strategy is used, these two parameters will be automatically set by your HFA II.

Post-processing

You will notice at the conclusion of a SITA test that there is a delay before the final data are presented on the screen. This delay in presentation is due to the post-processing of the testing data. It is normal. See Appendix G: "How SITA Works," item 4, for more information.

File directory indication

On the File Directory screens, the SITA-Standard tests will be indicated by the letters "SS" and SITA-Fast tests will be indicated by the letters "SF". Example: SF-30-2.

Floppy disk storage

SITA generates and utilizes significantly more data. Therefore, SITA tests use more disk space than is required when storing Full Threshold or FastPac tests. Floppy disks with SITA tests stored on them may hold as few as 100 tests. The maximum number is 500 tests.

Note: Additional information on SITA can be found in Section 7: "SITA Printout Formats" and Appendix G: "How SITA Works".

BLUE -YELLOW (SWAP) PERIMETRY

Advantages of testing with blue-yellow perimetry

Blue-Yellow perimetry, also known as Short Wavelength Automated Perimetry, or SWAP, differs from standard automated static perimetry only in that a carefully chosen wavelength of blue light is used as the stimulus, and a specific color and brightness of yellow light is used for the background illumination. Except for these differences, SWAP is still a basic static threshold perimetry test in which standard Goldmann stimuli are presented in the standard way.

How blue-yellow perimetry works

Blue-Yellow perimetry has performed much better than standard computerized perimetry in several published longitudinal studies. Working independently, researchers from U.C. Davis¹, and U.C. San Diego² have found that Blue-Yellow perimetry identified early glaucomatous visual field defects years before they could be detected using standard white-on-white perimetry. In separate work, the Davis and San Diego teams also found that Blue-Yellow perimetry detected progression in glaucomatous field loss significantly earlier than did white-on-white perimetry^{3,4}. Other papers have found Blue-Yellow perimetry to be superior in managing ocular hypertensives and in detecting neurological disease^{5,6}.

Blue-Yellow perimetry isolates and measures Blue-Yellow ganglion cell function. The carefully chosen bright yellow background desensitizes the green and red cones, while having little effect on blue cone function. The narrow band 440 nanometer blue stimulus falls right on the peak sensitivity of blue cones. Thus, Blue-Yellow perimetry tests the blue cones and their ganglion cell connections.

There are at least two theories as to why Blue-Yellow perimetry provides earlier diagnosis. One theory suggests that the Blue-Yellow ganglion cells are selectively damaged in early glaucoma, and thus earlier Blue-Yellow perimetry diagnosis is just a function of testing the part of the visual system which is damaged first. A second theory suggests that early diagnosis is achieved simply because Blue-Yellow perimetry tests one of several pathways of the visual system; if only a small part of the system is tested, then there is less redundancy, and loss will be discovered earlier.

Established standards for blue-yellow testing

In the beginning of Blue-Yellow perimetry development, there was little agreement on exactly how testing should best be done. The wavelength of the blue stimulus, the wavelength and brightness of the yellow background, and what stimulus size should be used were all considered. Four years ago, teams at U.C. Davis, U.C. Berkeley, and U.C. San Diego began working together under the sponsorship of Humphrey Systems to resolve the differences in their approaches and to define an optimized common standard. They presented their recommendations to a larger group from North America and Europe for peer review, criticism, and finally, acceptance. Out of this process has come an internationally accepted standard for Short Wavelength Automated Perimetry⁷. The Blue-Yellow perimetry system now being offered on the Humphrey perimeter adheres to this standard.

Note: References are listed in Appendix D along with a Blue-Yellow conversion table and Blue -Yellow specifications. Additional information on Blue-Yellow test interpretation can be found in Section 7.

Patient selection for
blue-yellow perimetry

Blue-Yellow perimetry has been found to be appropriate for early glaucoma detection in:

- ocular hypertensives
- glaucoma suspects
- as well as glaucoma patients with mild to moderate field loss.^{1,5}

While Blue-Yellow perimetry has the potential of becoming the primary perimetry method used in glaucoma management, we recommend that it be done as a complement to standard Humphrey white-on-white testing until more clinical experience has been gained.

For Neurological Disease:

At least one study has demonstrated that Blue-Yellow testing may be an appropriate and useful test in neurological disease⁶. With greater clinical experience, Blue-Yellow testing may become the primary perimetric testing method in neurological disease; initially, however, it should be used as an adjunct to standard perimetry.

Patients who may not be candidates:

There are some patients who may not respond well to Blue-Yellow perimetry. This includes patients with:

- significant cataracts
- advanced White-on-White field loss.

Blue-yellow testing

The procedure for testing with Blue-Yellow perimetry is identical to the procedure for testing with white-on-white. One important, additional step is to explain to the patient what to look for. The stimulus may appear as a localized color change (from yellow to violet) or sometimes as an achromatic spot. Users might find it helpful to use the Demo feature or a foveal threshold test to show patients what the new stimulus looks like before testing.

Many patients prefer the standard white-on-white perimetry, even though SWAP testing conditions are no brighter than standard indoor lighting levels. If patients understand what to expect they are much more accepting of new technologies — especially if they also understand that they will benefit in the process. We believe that when your patients have been properly informed about the benefits of Blue-Yellow perimetry, they will adapt to the new test quite well.

When Blue-Yellow testing is activated:

- the bowl illumination changes to yellow
- the stimulus color changes to blue
- the stimulus is changed to Size V (Blind spot check size also changes to Size V)
- Short-term Fluctuation (SF) is turned OFF.

These are the standard settings for performing Humphrey Blue-Yellow perimetry.

Room illumination should be off or at a very low level in order to preclude significant amounts of stray light from falling on the bowl and affecting Blue-Yellow test conditions.

1 From the Start of Test screen select CHANGE PARAMETERS. Switch Blue-Yellow from Off to On and press SELECTION COMPLETE.

2 Move the visor handle located under the forehead rest towards the bowl (away from the patient). See Figure 4.3. This helps to shield the patient's eye from the glare produced by the yellow bowl light. Press OK on the reminder message after you have extended the visor.

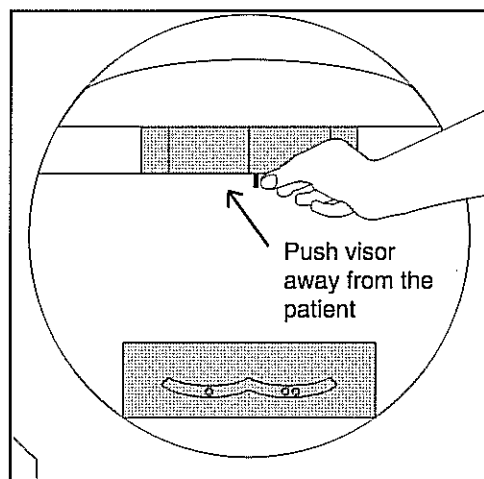
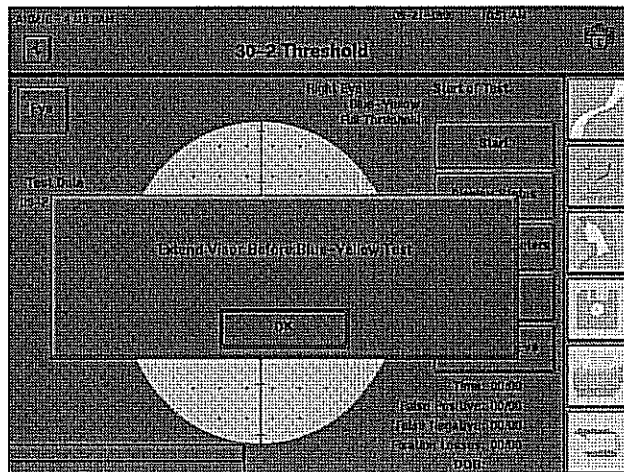

Figure 4.3: Extending the Visor Away From the Patient

3 Follow the standard testing procedures normally used for white-on-white perimetry for setting up and explaining the test. The patient's test eye should adapt to the yellow bowl illumination for about three (3) minutes before beginning the test. Having the patient look into the bowl while you enter patient data and explain the test will help to save time. Repeat the 3 minute adaptation period for the second eye.

Note: The Size V Blind Spot check may cause artificially high fixation losses on certain patients. You may wish to turn off the blind spot monitor and utilize only Gaze Tracking to monitor fixation when testing these patients.

4 At the conclusion of Blue-Yellow testing, slide the visor back into the forehead rest. See Figure 4.4.

A message will remind you to replace the visor beneath the forehead rest. Move the visor toward you (away from the test bowl). If the visor is not retracted, stimuli in the superior visual field may not be seen beyond 35 degrees during White-on-White testing.

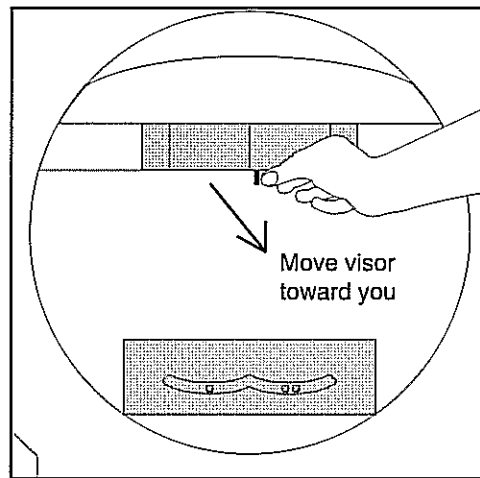
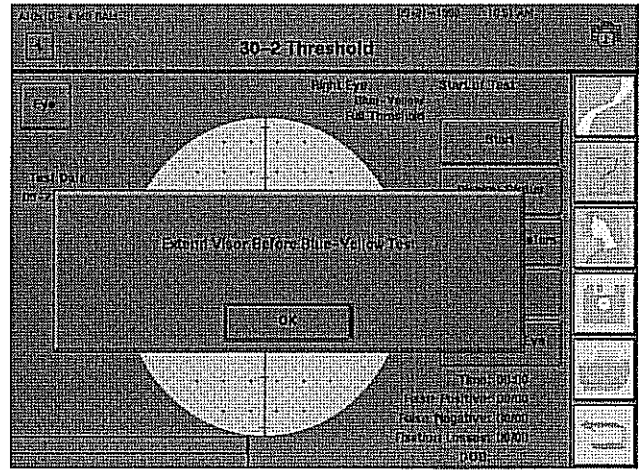

Figure 4.4: Returning the Visor to the Retracted Position

Additional Notes on Blue-Yellow Perimetry:

1. Be careful to check the instrument before starting the first test of the day to see that the visor is placed in the retracted position. The visor reminder is not displayed at start up.
2. When beginning the first Blue-Yellow test of the day, the HEA II will go through an extensive diagnostic cycle before you can begin the test. This delay may last up to two minutes and is normal. It is suggested that you set up the first Blue-Yellow test before you seat the patient. Many offices do this when they first turn on the instrument for the day. Be sure to have the room lights very low or off during the initial Blue-Yellow warm-up.
3. If you intend to perform Blue-Yellow testing often, using the Alter Main Menu feature (Section 2) to customize a Main Menu button will make SWAP testing more convenient.
4. Blue-Yellow testing cannot be used with Sma.

5. *Corrected Pattern Standard Deviation (CPSD) values are not available when Short-term Fluctuation is turned OFF. Fluctuation may be turned ON at the Parameter Setup screen without altering any other test parameters. The test will run longer as the HEA II retests additional points when fluctuation is turned ON. If you wish to run most Blue-Yellow tests with fluctuation ON, refer to Section 2: "Altering the Main Menu Screen".*

6. *Blue-Yellow perimetry tests take only about 15% longer than conventional perimetry. The most likely explanation for this is simply that current testing algorithms are not fully optimized for Blue-Yellow. In any case, 15% is only about 1 additional minute in a 6 minute test, and does not appear to be a serious drawback. SWAP and STATPAC for Blue-Yellow both fully support the use of FastPac. Using FastPac will greatly improve patient acceptance simply because it significantly shortens test time.*

Specificity of blue-yellow testing

Specificity is the ability of a diagnostic technique to correctly identify actual normals as being normal. Humphrey's STATPAC for Blue-Yellow was designed to provide the same level of specificity for SWAP as currently enjoyed in standard white-on-white Humphrey perimetry.

The original Blue-Yellow research protocols called for laborious determination of the yellowness of the crystalline lens. One conclusion of these protocols was that such measurements added little if anything to the diagnostic power of the procedure⁸. Measurement of the crystalline lens does add information about the overall height of the hill of vision, but most of the visual field information used in glaucoma diagnosis has to do with localized sensitivity loss, not with general sensitivity. From a practical point of view, crystalline lens measurements do not appear to be worth the clinical time consumed.

Although Humphrey's Blue-Yellow Perimetry is available for screening tests in addition to threshold tests, research studies dealing with Blue-Yellow have involved threshold testing exclusively. Because screening strategies have been optimized for white testing, you may find an increased number of screening fields to appear abnormal. We suggest for now you use Blue-Yellow testing only with the threshold testing strategies.

ALTERNATE COLOR TESTING

(models 730-750)

In addition to the standard white stimulus, all central field tests may be performed using a blue or red stimulus on a white background. The filters to create the colored stimuli are listed and characterized below.

Color	Filter
Blue	440 nm Blue (models 745, 750)
	OCLI Dichroic Blue (models 730, 735, 740)
Red	Hoya R62

Note: This is not the same as Blue-Yellow Testing. See previous discussion for details.

Performing a color test

1. From the start test screen, select CHANGE PARAMETERS.
2. Open the stimulus color drop-down menu and choose either BLUE or RED.
3. Proceed as you would for any white stimulus test.

Note: The decibel to apostilb comparison chart in the Appendix is different in color testing than it is in white testing. In color testing, zero decibels still represents the maximum instrument brightness although that maximum brightness is less than 10,000 asb. Decibel values are still valid for comparison of relative brightness for a given color filter.

Start Test Options	5-2
Monitoring and Maintaining the Patient's Eye Position	5-4
Supplemental Testing	5-7
Test In Progress	5-10
Test Complete Options	5-14
Testing: A Step-by-Step Guide	5-16

During the testing phase, your responsibility shifts to monitoring the patient's progress to ensure a successful outcome and reliable results. This section explores your options available during the test. It helps to answer the following questions, and others:

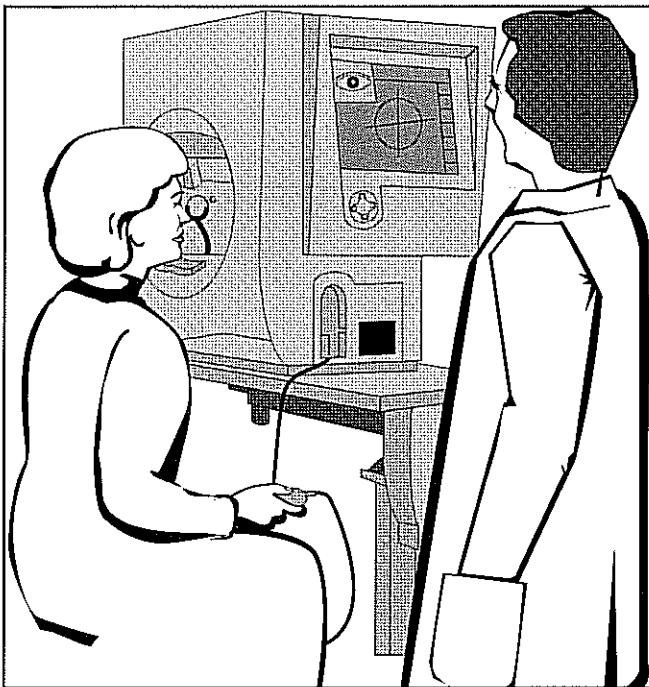

- How do I pause the test to allow the patient to rest?
- If I've chosen the wrong eye to begin testing, how do I switch?
- Can I restart a test once it has begun?
- How do Head Tracking and Vertex Monitoring help when trial lenses are used?
- Must I print the test results immediately following a test?

START TEST OPTIONS

After you have chosen a test and specified which eye is to be tested, you will arrive at the Start of Test screen. From this screen you can start the test, display a list of all current parameters, change the parameter settings, and change the test eye.

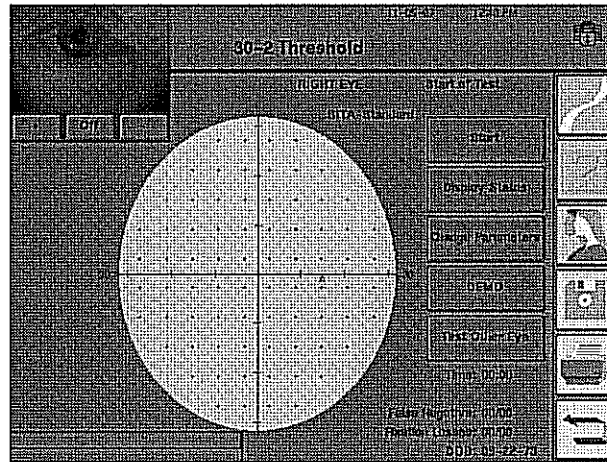

Figure 5.1: The Start of Test Screen

**START**

This button initiates the testing sequence, starting with supplemental testing, if chosen.

Supplemental tests include foveal threshold measurement or initialization of the Gaze Tracking fixation monitoring system (models 740-750). Refer to "Supplemental Testing" in this section for additional information.

**DISPLAY STATUS**

This choice presents a display of all current test parameter settings. Select OK to collapse the pop-up window. You cannot change any setting through DISPLAY STATUS. These settings must be changed by pressing CHANGE PARAMETERS as described in Section 4. The test continues to run when DISPLAY STATUS is selected during a test.

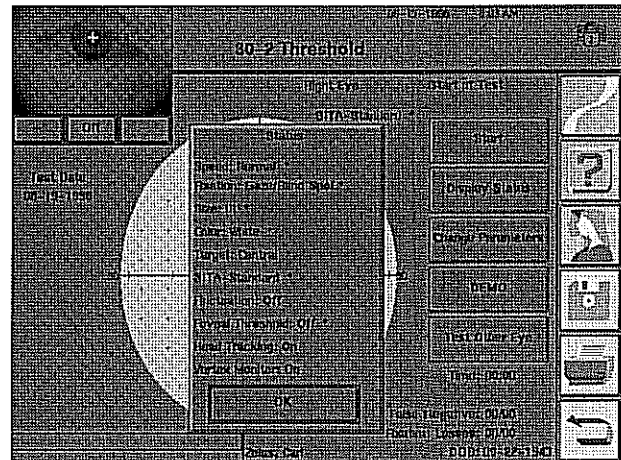
**CHANGE PARAMETERS**

This function allows you to alter any testing parameter (e.g. test speed, stimulus color) prior to starting the test. Once the test begins, only two parameters may be changed: fixation monitoring and test speed. See previous discussion in Section 4: "Setting Test Parameters" for details.



DEMO

This feature runs a short practice test. Demo allows the patient to preview what is required during a visual field test. It also allows you to evaluate whether the patient understands your instructions and the use of the patient response button. Patient responses are not recorded during the Demo test. The Demo test starts immediately after you press DEMO.

The Demo test will run for one minute unless you choose to end the Demo test sooner. Once the patient demonstrates competency, press END DEMO to begin the actual test. If END DEMO is not pressed, the pop-up window will disappear after one minute. The test will immediately begin.

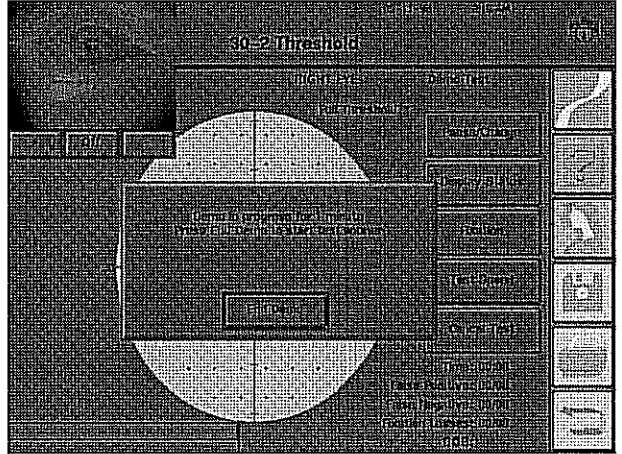

Note: The Demo test runs only after the Foveal Threshold is determined and the Gaze Tracking initialization is complete (if utilizing either of these features).



TEST OTHER EYE

This button allows you to switch to the Start of Test screen for the other eye. You will be allowed to add or change patient data at this time.

INTERNAL DIAGNOSTIC ALERT

Frequently, after selecting START or TEST OTHER EYE, the message "Please Wait... Preparing Instrument For Test" appears on the screen. This is a normal function of your instrument. The HFA II is performing a short, self-diagnostic check prior to beginning the test.

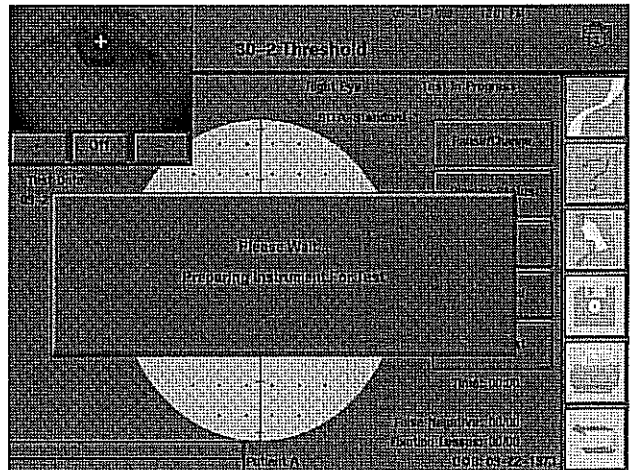

MONITORING AND MAINTAINING THE PATIENT'S EYE POSITION

Video Eye Monitor

All HFA II models feature a video eye monitor. This monitor, which is automatically visible on the Start of Test screen, enables you to view the patient's test eye. Accurate placement of the eye is important. When the cross-hatches are seen over the pupil, the eye is centered.

Use the video eye monitor to:

- position the test eye in the center of the trial lens holder
- monitor the patient during testing.

The three controls on the video eye monitor are: a plus sign (+) to brighten the image, a minus sign (-) to dim the image, and an OFF button to turn off the monitor display. To re-display the monitor, press the upper-left EYE button.

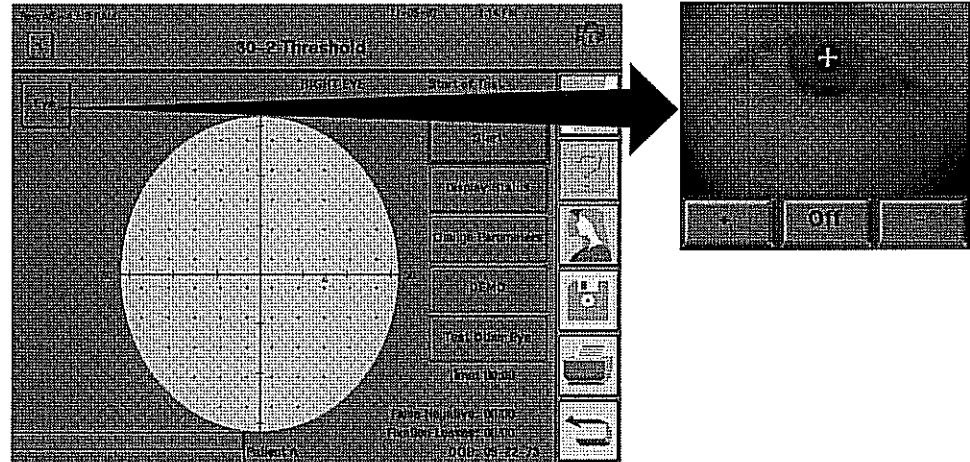

Figure 5.2: The Video Eye Monitor

Gaze Tracking (models 740-750)

Gaze Tracking is a unique fixation tracking system that records whether the patient is properly fixating while stimuli are being presented. A brief initialization procedure is required at the start of each test to calibrate and adjust the gaze tracker to the patient's eye. It is imperative, therefore, that the patient maintain the same position during gaze initialization and testing. Deviations are recorded and displayed on the test screen and on the printout.

Note: Some patients with small pupils, ptotic lids, interfering lashes, or strong prescriptions may not be good candidates for the gaze monitoring.

At the Start of Test screen, you can make changes to the fixation monitoring system or turn the monitoring system off entirely by pressing CHANGE PARAMETERS. Gaze monitoring may only be selected at the start of a test, although it may be turned off at any time during the test.

The gaze graph

The gaze graph is a useful method for documenting movement of the patient's test eye. A test starts with no markings on the gaze graph. As time progresses, the graph expands from the right, marking eye movement and blinks.

Upward markings indicate that the test eye deviated from the fixation target at the time of stimulus presentation. The higher the marking, the greater the deviation. The direction of deviation from the fixation target is not indicated. Only the magnitude is recorded.

Downward markings indicate that the gaze system could not locate the patient's gaze: small downward markings indicate that the system was unable to detect gaze direction; large markings indicate that the patient blinked while the stimulus was being presented. Minimal deviation of the markings (depicted as a horizontal line) indicates excellent fixation. Refer to Figure 5.3 for an example of a gaze graph that displays an example of good fixation. An example of poor fixation is shown in Figure 5.4.

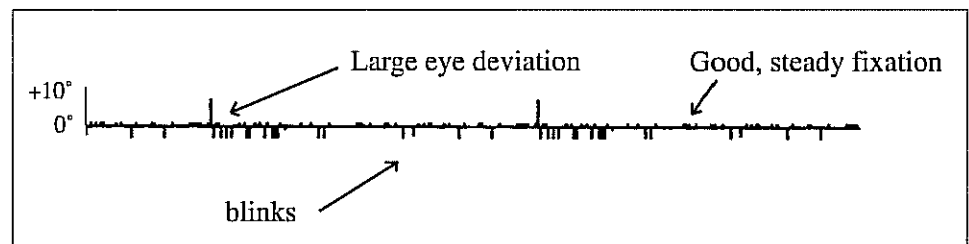

Figure 5.3: Example of a Gaze Graph: Good Fixation with a Large Number of Blinks

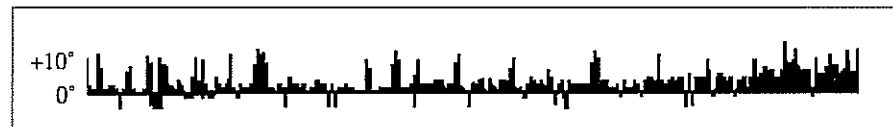

Figure 5.4: Example of a Gaze Graph Indicating Poor Fixation

Head Tracking
(model 750)

The Head Tracking feature helps maintain proper alignment of the head and eye relative to the trial lens holder. As part of the gaze initialization process, the HFA II analyzes and records the patient's eye position. When Head Tracking is turned ON, the instrument will move the chin rest in increments of 0.3 mm, readjusting the patient to the original Gaze Track initialization position. Maintaining proper alignment during testing reduces trial lens scotoma and increases the reliability and accuracy of test results.

Note: Head Tracking only works when the trial lens holder is in use and Gaze Tracking has been successfully initialized. Head Tracking is only necessary when a trial lens is used. To turn Head Tracking off during a test, press FIXATION to access the Change Fixation Monitoring screen. Head tracking is only turned off for the length of the current test.

It is possible in certain situations for the Head Tracking feature to “lose its place”. The most common reason for this is a sudden shift of the eye or repositioning of the head. A patient whose head does not move with the chin rest will cause Head Tracking to beep. A pop-up window will appear giving you the opportunity to continue or discontinue

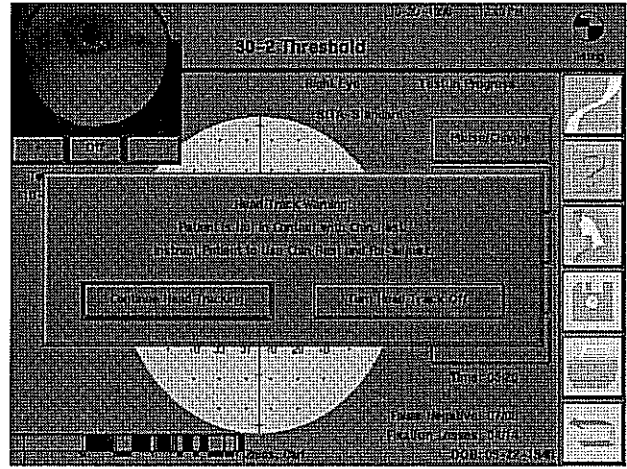

using Head Tracking. The HFA II continues testing while the message is on the screen. You should re-instruct your patient at this point. Make sure that the chin rest supports the patient's head. This will ensure that the head moves with the chin rest.

Vertex Monitor (model 750)

The Vertex Monitor will beep and display a message on the touch screen if the patient backs away more than 7 mm from his or her original position. This helps to eliminate the trial lens as a source of visual field defects. Refer to Section 2: “System Setup – Vertex Monitor” for instructions on turning on the Vertex Monitor.

The vertex reading is based on the initial patient position in front of the trial lens. To set:

1. Make sure that the trial lens holder is in the up position in front of the eye
2. Properly align and instruct the patient
3. Initialize the Gaze Tracking feature

The Vertex Monitor alarm will beep if the patient has backed away from the trial lens. Testing will continue uninterrupted and a message will remain on the screen until cleared by the operator. Check the position of the patient's forehead and reposition if necessary. If the Vertex Monitor continues to sound, press RE-INITIALIZE VERTEX. The test will pause as the screen displays the Gaze Track initialization sequence. This will reset the Vertex Monitor. The Vertex Monitor may also be turned off from this screen or by pressing FIXATION from the Test in Progress screen. The Vertex Monitor is turned off only for the length of the current test.

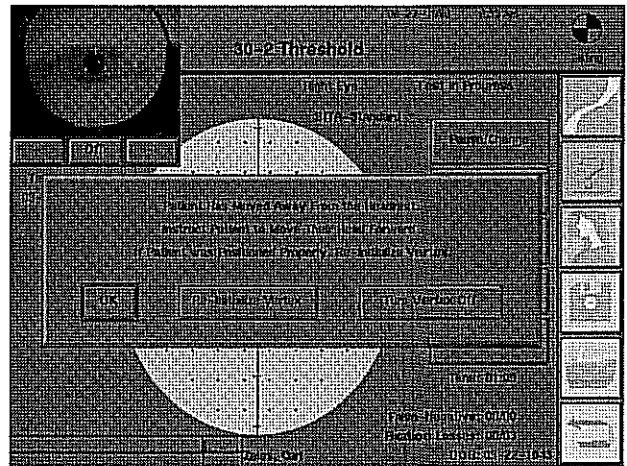

Note: The Vertex Monitor only works when the trial lens holder is in use and Gaze Tracking has been successfully initialized. The Vertex Monitor is only necessary when a trial lens is used.

SUPPLEMENTAL TESTING

Foveal Threshold

Foveal Threshold and Gaze Track Initialization are performed before a test begins. They are called "supplemental tests".

The Foveal Threshold test determines the decibel value of the central part of the macula, the fovea. Whenever the Foveal Threshold parameter is turned ON, the Foveal Threshold test is the first supplemental test procedure. Press CHANGE PARAMETERS to turn Foveal Threshold ON.

1 After pressing START, the Foveal Threshold test will be initiated.

2 The small diamond fixation target will light up below the central fixation target. Instruct the patient to look at the center of the lower fixation lights (in the center of the diamond).

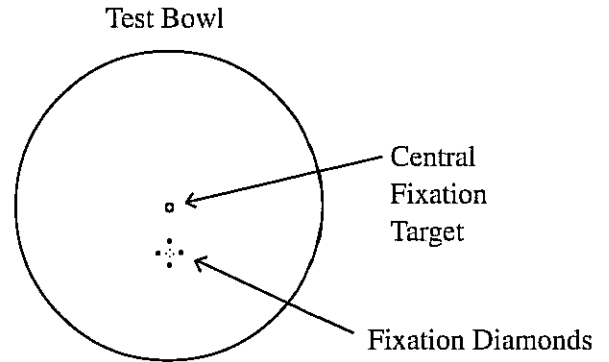

3 Tell the patient to press the response button whenever a light is seen inside of the fixation diamond.

4 Press START to begin the Foveal Threshold test.

5 When completed, a second pop-up window will appear. The yellow light will return to the Central fixation target.

Direct the patient to look at the central fixation light. Press START to begin Gaze Tracking initialization (or begin the test if Gaze Tracking is inactive).

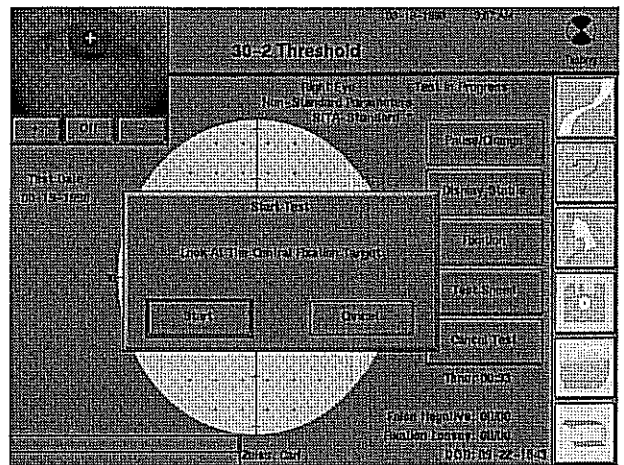

Note: The Foveal Threshold value will be displayed in the center of the visual field on the test screen. It is recorded below the reliability indices on the printout.

Gaze tracking initialization

The advantages of Gaze Tracking were previously explained in this section. If gaze monitoring is active, the Gaze Tracking initialization will occur before the testing begins.

1 From the appropriate testing screen, press the START button.

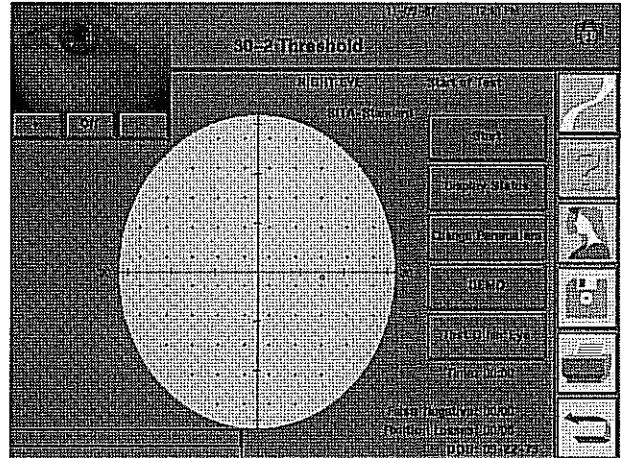

2 When gaze monitoring is engaged, you will automatically get an operator message.

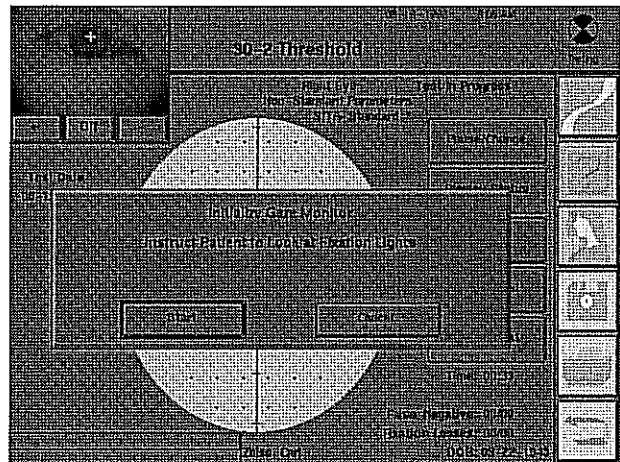

3 Position the patient so that the patient's test eye is located in the center of the video eye monitor (within the small, central box). Use the chin rest control to adjust the patient. The cross-hatch sign should be in the middle of the pupil, as shown.

4 Instruct the patient to look at the fixation target and try not to blink, for about a count of twenty, or until you tell them that the process is over.

5 Press START to initiate gaze setup. Pressing CANCEL returns you to the Start of Test screen.

Notes:

- 1.** Patients with droopy eyelids should keep their eyes open as wide as possible. Do not adjust the chin rest during Gaze Tracking Initialization.
- 2.** Do not attempt to use gaze tracking if using one of the lower fixation targets (Small diamond, Large diamond, Bottom LED). Use Blind Spot instead. The blind spot monitor is off-set the appropriate amount to compensate for the different angle of fixation when using the lower fixation targets. Gaze Tracking needs the patient to be looking at the Central fixation target to be effective.

6 If Gaze Track Initialization is successful, press CONTINUE to begin testing.

Note: It is important that the patient maintain the same position during gaze initialization and testing.

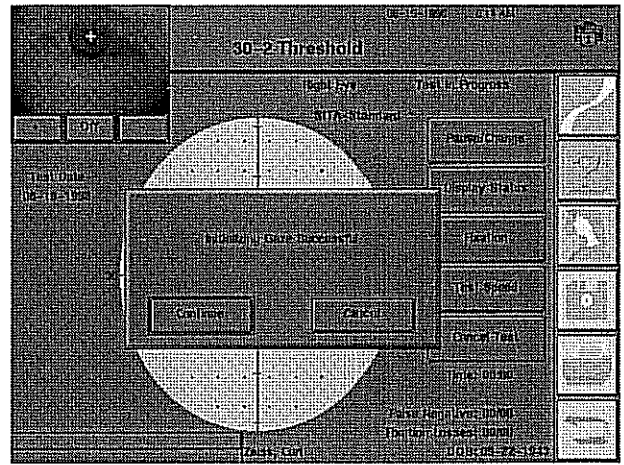

7 If Gaze Track Initialization is unsuccessful, press RE-TRY TO INITIALIZE GAZE. Refer to "Fixation Monitoring" in this section if you are faced with repeated unsuccessful attempts.

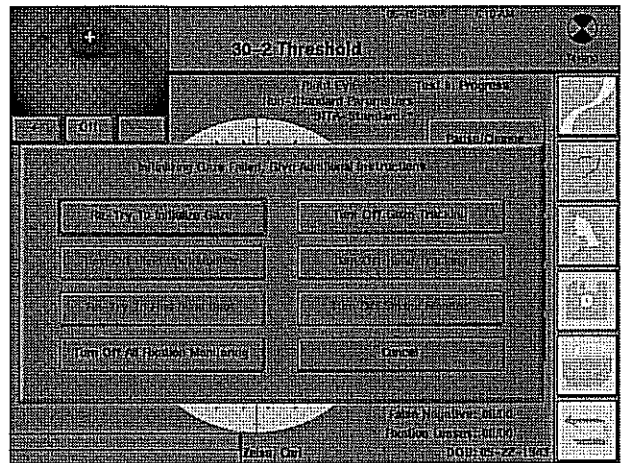

TEST IN PROGRESS

You have several options while a test is in progress.

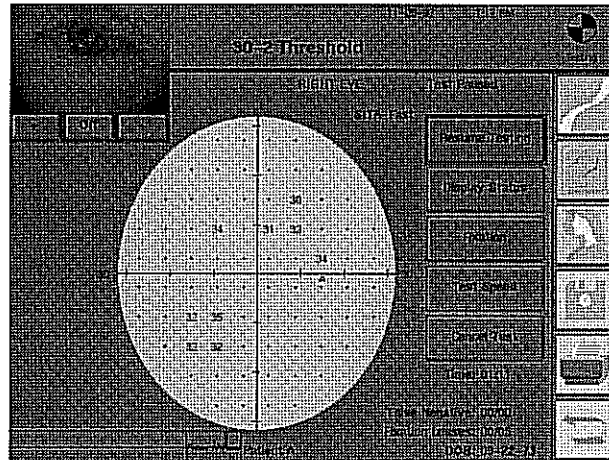
**PAUSE**

This button halts the test and allows the patient to rest. The patient can also pause the test by continuously holding down on the response button.

Once in the pause mode, you may choose to resume the test, display the current test parameter settings, change the fixation monitoring system, change the test speed, or cancel the test.

If you cancel the test while in the Pause mode, all data collected up to that point will be deleted and the program will return to the Start of Test screen. Non-standard parameters will be retained, if originally chosen. Before the instrument deletes the data, you will be asked to confirm your request.

**DISPLAY STATUS**

This feature is available to you during testing so that you can verify the current parameter settings.

**FIXATION**

This button gives you the option of changing the fixation monitoring during the test. Gaze monitoring cannot be initiated once the test has begun.

**TEST SPEED**

During testing, the instrument automatically adjusts the test speed based on how quickly or slowly the patient responds to the stimuli. Nevertheless, if you observe that the pace is too fast, the TEST SPEED button will allow you to slow the test manually. Press the SLOW button to change the pace of the test program. The test speed will reset to normal at the completion of the test.

**CANCEL TEST**

This choice will discontinue the test, delete all results, and return you to the Start of Test screen. Non-standard parameters will be retained, if originally chosen. Before the instrument deletes the data you will be asked to confirm your request.

Printing partial tests



If a test is paused or cannot be run to completion, it may be printed by pressing the *PRINT FUNCTIONS* icon button. Partial tests cannot be saved. Paused tests may be resumed after printing and saved when completed.

Fixation monitoring

The test will pause when the **FIXATION** button is pressed. It will remain paused while the fixation monitoring screen is displayed. Pressing any of the available buttons will change the parameter for the remainder of this test only. All monitoring devices will revert to the previous settings for testing the next eye.

A "ghosted" button indicates either that choice is not available or the feature is not an option with your model HEA II. After one of the following options is chosen, the test will continue.

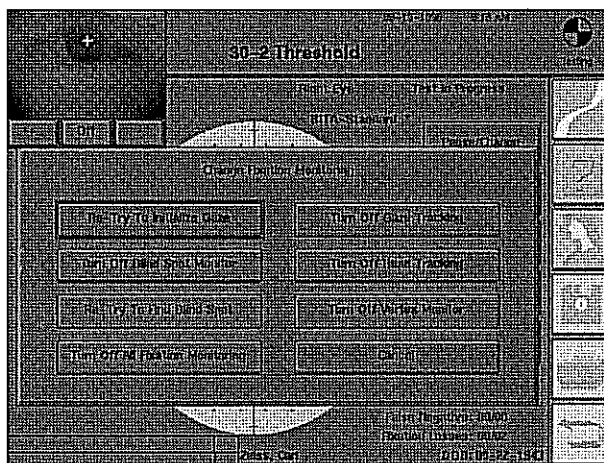

RE-TRY TO INITIALIZE GAZE

This will repeat the initialization process for Gaze Tracking. The Head Tracking and Vertex monitoring systems will be re-initialized at the same time. Appropriate situations to re-initialize gaze are:

- The patient dramatically shifted his or her eye position.
- The Gaze Graph indicates poor fixation even though the patient was fixating in a steady manner.
- Many downward markings show on the Gaze Graph indicating that Gaze Track was having trouble detecting the patient's gaze direction.
- Head tracking moved the patient's head too far in the wrong direction.
- The vertex monitor alarm was sounding too often, even with good head positioning.

Turn Off Blind Spot Monitor

TURN OFF BLIND SPOT MONITOR

Press this button to turn off the Heijl-Krakau method of Blind Spot Monitoring. If Gaze/Blind Spot had been chosen at the start of the test and gaze tracking is initialized, the gaze tracking will continue to monitor fixation while the blind spot monitor is turned off. If both gaze tracking and blind spot monitoring are turned off, you can visually assess the patient's ability to fixate by observing with the video eye monitor.

Re-Try To Find Blind Spot

RE-TRY TO FIND BLIND SPOT

This will initiate discovery of the patient's blind spot by using the stimulus to search in the area of the blind spot for the exact location. This is sometimes necessary, for example, when the patient's head tilts during the test.

Turn Off All Fixation Monitoring

TURN OFF ALL FIXATION MONITORING

This will turn off both Gaze Tracking and Blind Spot Monitoring if pressed. In this case, you can monitor the patient's fixation by watching the video eye monitor for the duration of the test. Both Head Tracking and Vertex Monitoring will be turned off as well when Gaze Tracking is discontinued.

Turn Off Gaze Tracking

TURN OFF GAZE TRACKING

This will turn off the Gaze Tracking device as well as Head Tracking and Vertex Monitoring for the current test. Blind spot monitoring is not affected.

Turn Off Head Tracking

TURN OFF HEAD TRACKING

Only Head Tracking will be turned off by pressing this button.

Turn Off Vertex Monitoring

TURN OFF VERTEX MONITORING

Only the Vertex Monitor will be turned off by pressing this button.

Note: Putting the trial lens holder down during the test will also turn off the Head Tracking and Vertex Monitoring devices. You should never put down the trial lens holder after the test has begun.

Cancel

CANCEL

This button will resume testing without any changes.

Tips for Gaze Tracking and Head Tracking

The keys to successful Gaze and Head Tracking are the same keys that make for successful visual field testing. Make sure the patient's chair has been moved close enough to the instrument, and that the patient is sitting in a comfortable and erect position. Remember to slide the instrument toward the patient so the patient can sit in a comfortable, upright position.

Always monitor and encourage the patient. Early correction of any poor compliance will help to increase the reliability of the visual field results.

Gaze Tracking may not work well in the following situations:

- Very small pupils or droopy eyelids.
- High powered trial lenses.
- Excessive eye movements.
- Cloudy media.

Remember, if Gaze Tracking does not initialize successfully, Head Tracking, pupil size measurement, and Vertex Monitoring cannot be utilized. Blind spot monitoring and visual observation are still available to assess the reliability of the patient results in these cases.

TEST COMPLETE OPTIONS

Saving to disk

Two beeps sound to signal the end of the visual field test. At that time, you can save the results to the hard disk or a floppy disk, test the other eye, or print a hard copy of the test results. You should always save results before proceeding with other options.

You will be asked to confirm that the patient's name and date of birth are correct. You may accept the patient data, change patient data before saving the test results, or return to the Test Complete screen without saving test data. Remember to have a floppy disk in the floppy drive when you press YES to save.

Note: There is a slight delay at the end of a Sma-Standard or Sma-Fast threshold test for the post-processing function to occur. Saving and printing can occur as normal at the end of this phase.

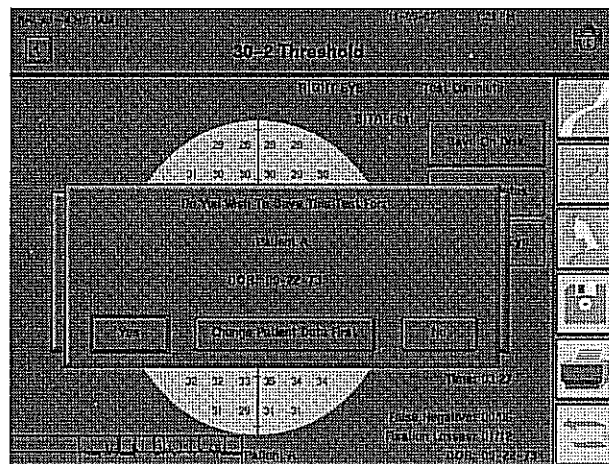

Figure 5.5: Do You Wish to Save this Test?

The test complete screen



The following buttons are displayed on the Test Complete screen:

SAVE ON DISK

You may save the test result with this button. It allows you to save a test more than once. This is important if you are saving to more than one floppy disk at the end of a test, for example. This button will also allow you to save a test if you had previously decided not to save it. This may have happened if you pressed the NO button shown in Figure 5.5.

DISPLAY STATUS

This button is available so that you can verify the parameter settings of the completed test.

TEST OTHER EYE

This choice switches to the Start of Test screen for the other eye. It also prompts a pop-up screen asking for confirmation of patient data. All current test parameters remain in effect.

ZOOM

This button is found at the end of Full Field Screening tests to better display points in the central 30 degrees on the screen. Press ZOOM a second time to expand back to full field size.



PRINT

To get a copy of the results immediately following a test (or during a pause for partial results), select the *PRINT FUNCTIONS* icon button. This takes you to the Printout Selection screen. See Figure 5.6 below.

The top of the Printout Selection screen shows the current test(s). If the *PRINT FUNCTIONS* icon button was selected before the second eye was tested, or if only one eye was intentionally tested, then only a single test will appear. If test results for both eyes are available, the printouts may be printed at the same time. There are different printout selections for screening and threshold tests.

The two available screening print formats are Screening Test, which prints each test on a separate page, and Both Eyes, which condenses the two test results to one page. There are several threshold print formats: Single Field Analysis, Overview, Change Analysis, Glaucoma Change Probability Analysis, and Three-in-One. Only the Three-in-One is a non-STATPAC format. Refer to Section 7 for a detailed description of each format and printing instructions.

You do not have to print results immediately following a test from the Test Complete screen. By saving test results to disk, you have the ability to print at any time convenient to you by means of the *PRINT FUNCTIONS* icon button. You can also print the test results of the last right and left eye through RECALL LAST TEST on the Main Menu screen, providing the instrument was not turned off. The Test Complete screen will be displayed when viewing a test via RECALL LAST TEST.

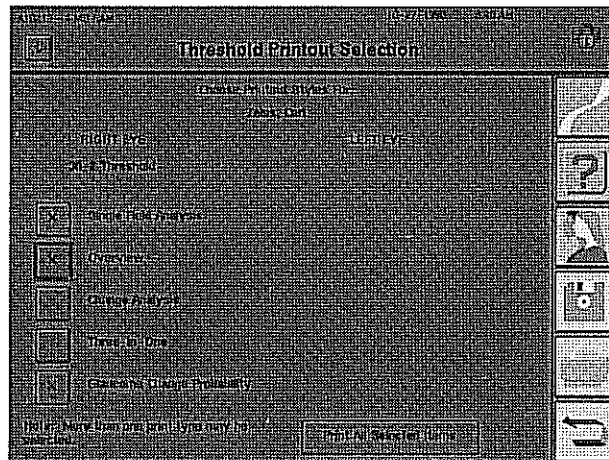
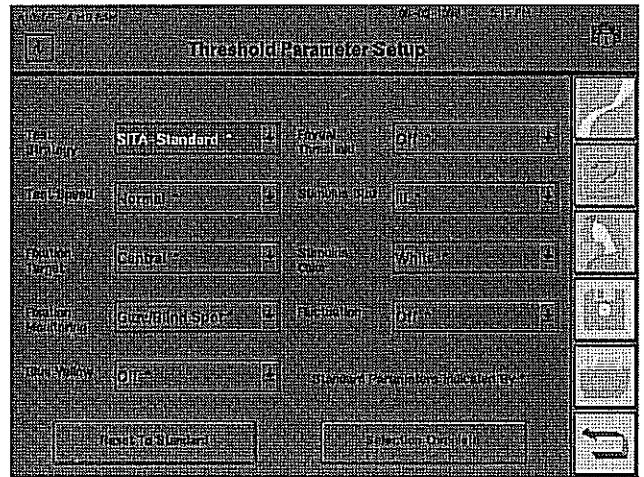

Figure 5.6: The (Threshold) Printout Selection Screen

4 Change test parameters. Select the test parameters and the fixation monitoring system to best suit your patients' needs.



5 Patch the non-test eye. Give the patient test instructions. Adjust the table and perimeter to a comfortable height for the patient. See Section 3: "Preparing the Patient".

6 Press START.

7 If the Foveal Threshold parameter is turned on, it will activate now. Refer to the earlier discussion in this section on "Foveal Threshold".

8 If the fixation monitoring parameter is set to "Gaze Track" or "Gaze/Blind Spot", follow the on-screen instructions for setup. Refer to "Gaze Tracking" for details. After gaze monitor initialization, a pop-up window appears and prompts you to start the test. Remember to monitor the patient during the visual field test to insure accurate results.

9 If necessary, PAUSE the test. Pausing the test can improve test results in easily fatigued patients. Check patient alignment through the video eye monitor before resuming the test.

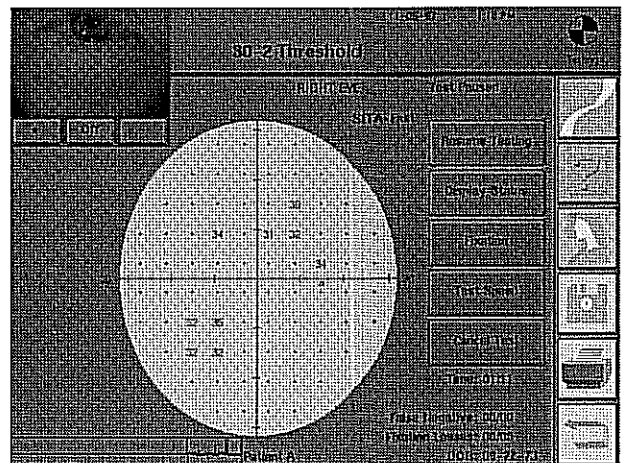

10 When complete, select an end of test option.

Be sure to save the test results at this point.

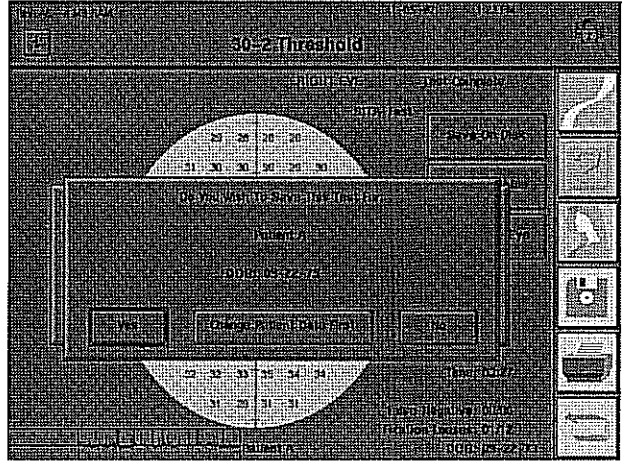

11 Test the other eye. Retain or change patient data, as necessary. Repeat Steps 4-10.

Test Reliability

Factors Affecting Reliability	6-2
Patient Compliance	6-2
Patient Fixation	6-3
Trial Lenses	6-3
Evaluating Reliability	6-4
Fixation Losses	6-4
False Positive Errors	6-4
False Negative Errors	6-6
Fluctuation Values	6-6

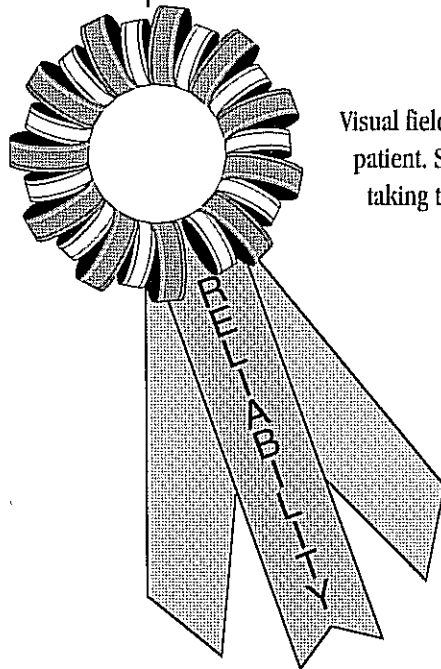

Visual field testing represents a team effort between the perimetrist and the patient. Success, as measured by reliable test results, is best attained by taking the necessary steps and precautions to help the patient take the test.

FACTORS AFFECTING RELIABILITY

Patient compliance

The importance of the perimetrist reigns above all other factors affecting test reliability. This was true before the advent of automation and still proves to be true with computerized perimetry. The "human factor," that is, the interaction between the perimetrist and the patient, cannot be overlooked when discussing test reliability.

It is the perimetrist's job to promote patient cooperation and to motivate the patient to put forth his or her best effort.

Tips for achieving patient compliance:

- **Create the proper environment.**
Do not position the perimeter in a noisy or busy location where the patient can be easily distracted while listening to test instructions or while taking the visual field test.

Keep the room temperature cool so the patient is less likely to become drowsy.

- **Foster a relaxed atmosphere.**
Vision tests sometimes make patients anxious, especially if it is a new experience. Allow patients time to relax, use the rest room, or drink water.

- **Seat the patient comfortably.**
Use an adjustable office chair (with or without arms) to accommodate tall and short patients. The perimeter and table will accommodate a full-size office chair with arms or a wheelchair. Be sure to slide the instrument toward the patient and adjust the table height to best meet comfort demands. The patient should be sitting comfortably erect, and not leaning excessively forward.

- **Give clear test instructions.**
Consider the possibility that the patient may not hear well. In such cases, face patients while explaining the test procedure so they can benefit from lip reading and gestures. Avoid giving instructions while the patient is wearing an eye patch.

Emphasize that it is normal and expected that many stimuli will not be seen. Threshold tests are designed such that fewer than 50% of the stimuli presented will be seen.

- **Keep the patient motivated during the test.**
Pause the test, as necessary, to allow the patient ample rest time. Encourage the patient frequently and assure them, by using verbal confirmations, that they are doing a good job (e.g. "You're doing fine" or "Keep up the good work").

Unless the patient has a proven record for reliability, don't abandon them during testing, especially during the first few minutes. Correcting a problem immediately may prevent having to repeat an entire test.

Patient fixation

Improper or erratic fixation may make test results meaningless. The perimetrist can play an important role by emphasizing fixation while explaining the test procedure.

Tips for improving patient fixation:

- Choose a fixation target that is appropriate for the patient. When you tell the patient to look at the yellow fixation light, verify that they can see the light by asking, "Do you see the yellow light? Is it clear?". If the light is not clear, consider modifying the trial lens correction. If the patient cannot see the light, for example, due to macular disease, change to the small or large diamond to help the patient fixate throughout the test.
- Use the Demo test to make sure the patient understands the test and is responding properly. Re-instruct the patient as necessary, especially if they are inclined to look around for stimuli.
- Fixation is more difficult with a dry cornea. Encourage the patient to blink normally whenever they press the response button. Lack of blinking can cause part of the visual field to "white out" for some patients.
- Inform your patient in advance that it is normal for the background to seem to change or for the fixation target to seem to move. Barring other problems, they should not let these phenomena distract them. Encourage them to take breaks and pause the test by holding down on the response button if fatigue is a problem.
- Observe the patient by means of the video eye monitor. Encourage correct behavior.
- Record any observations that are relevant to reliability by entering your comments on the patient data screen, or by writing your comments directly on the printout.

Trial lenses

Using trial lenses incorrectly or using none when one is needed is another source of unreliable test results.

Things to remember about trial lenses:

- Use a trial lens, when necessary. Use only the thin, wire-rimmed variety. Let the automatic calculation program (see Section 3: "Inputting Trial Lens Data") determine the correct lens power to use. Verify with the patient that the fixation light is not blurred.
- Use trial lenses only for central tests (within 30°), or the central part of a full field test. Remove trial lenses and lower the trial lens holder for peripheral tests (beyond 30°). You cannot start the peripheral part of a full field test until the trial lens holder has been lowered.
- Place the sphere correction in the slot closest to the patient's eye and the cylinder lens behind the sphere. Adjust the trial lens holder so that the lenses are as close to the patient's eye as comfort will allow, without touching any lashes.
- Tell the patient that it is important to stay close to the trial lens and centered behind it. Model 750 owners should use Head Tracking and Vertex Monitoring to help keep the trial lens centered and set at the proper distance (see Section 5).

EVALUATING RELIABILITY

Even with the most careful perimetric technique, sometimes test results are unreliable. To assist with evaluating reliability, the HFA II offers several tools that measure accuracy and consistency. "Catch trials" are special stimuli (or lack of) which are used for monitoring.

Fixation losses

When the fixation monitoring test parameter is set to blind spot (Heijl-Krakau) mode, proper fixation is checked by projecting 5% of stimuli at the presumed location of the physiological blind spot. Only if the patient indicates seeing the blind spot check stimulus will the instrument record a fixation loss. A high fixation loss score indicates that the patient did not fixate well during the test, or that the blind spot was incorrectly located.

The printout will show the total number of fixation losses followed by the total number of stimuli presented within the blind spot. In the example shown in Figure 6.1 below, the patient had 17 fixation losses out of a total of 26 check stimuli presented.

If fixation losses exceed 20%, XX will be printed after the score. When the test is in progress, the HFA II will beep once if the patient responds to two of the last five fixation checks. If, after hearing the beep, the patient appears to be fixating properly, you may wish to replot the blind spot. High fixation loss scores may be due to an erroneously plotted blind spot, caused by patient head tilt. Straightening the head, or replotting the blind spot can remedy this situation.

Gaze Tracking may be used as the sole fixation monitor or in conjunction with the Heijl-Krakau blind spot mode described above. If a patient has demonstrated both good fixation and test taking reliability in the past, you may prefer using just Gaze Tracking. Because blind spot monitoring adds time to the test, using the Gaze Tracker alone can shorten test time.

False positive errors

Another indication of poor reliability is when a patient responds to catch trials in which no stimulus has been projected. This is referred to as a false positive response and tracked as a false positive error.

The printout will show the total number of false positive errors followed by the total number of trials. If errors exceed 33% of the trials, XX will appear on the screen and on the printout although test reliability may be compromised at false positive rates that are much lower than 33%. A high false positive score may indicate that the patient is overly concerned about not seeing all the stimuli. The "trigger happy" person will need to be re-instructed and reassured that it is normal for many stimuli to be missed.

In addition to a high false positive finding, trigger happy patients often show threshold results that are abnormally high. An example of this phenomenon is shown in Figure 6.1. Any finding of 40 dB or greater indicates a hypersensitive result which can only be due to patient overreaction or guessing when pressing the patient response button. It is best to note the results early in the exam and start the test over than to allow the test to run to completion and be completely invalid.

Fixation Losses
 False Positive
 False Negative
 Abnormally high results

Gaze Graph

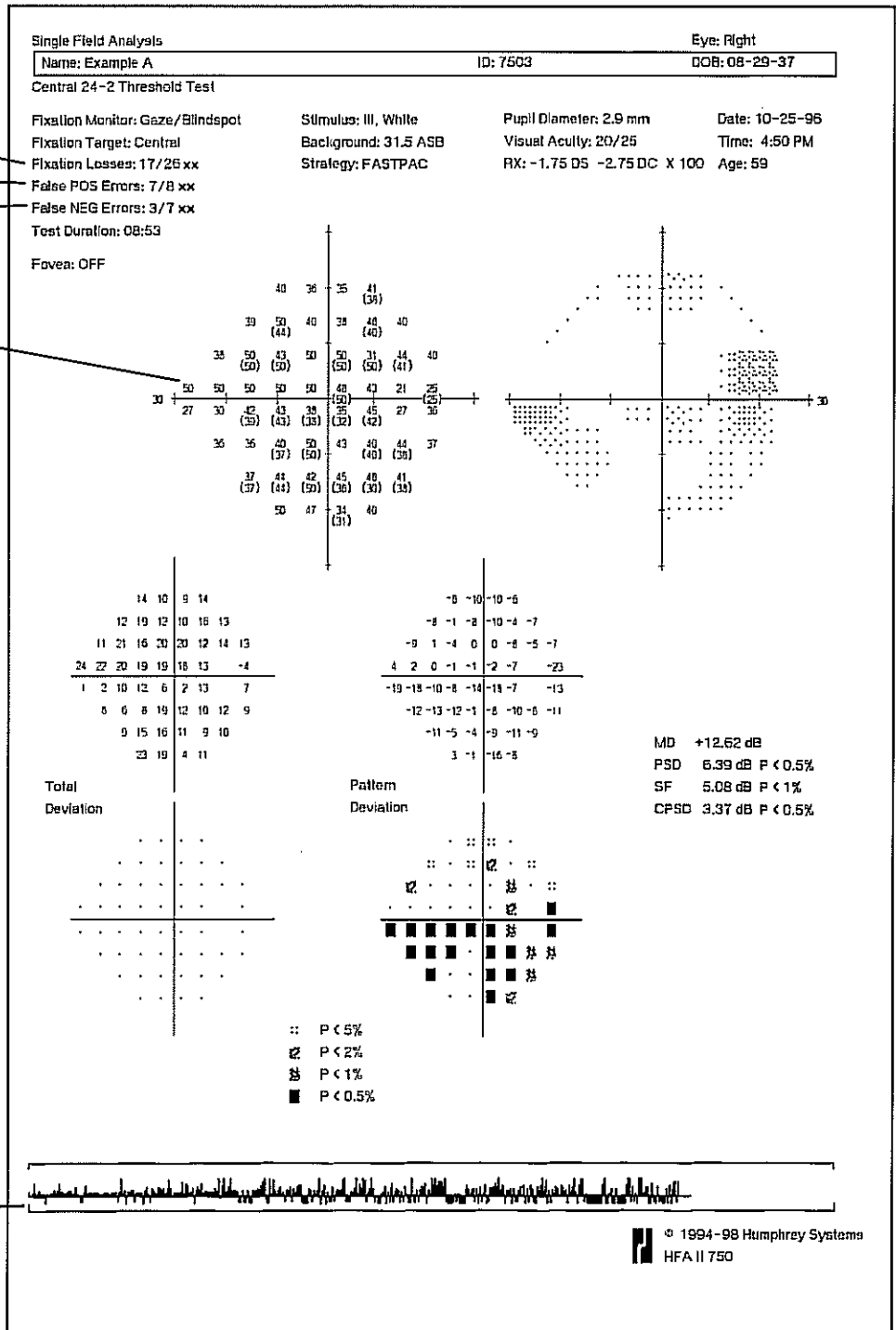

Figure 6.1: Sample Printout Showing Poor Reliability.

The example above indicates a very unreliable patient. A high number of fixation losses, false positive errors, and false negative errors have been recorded. Poor fixation is indicated by the gaze graph. Also note the number of points where threshold results are 40 dB or higher.

False negative errors

Occasionally during a test, a stimulus is repeated at a particular location and at a level much brighter than has already been seen. If the patient does not respond to this trial stimulus, a false negative error is recorded.

The printout will show the total number of false negative errors followed by the total number of trials. If errors exceed 33% of the trials, XX will appear on the screen and the printout. A high false negative score may indicate a fatigued patient, inattentive patient or a malingerer, but it is also commonly seen in reliable patients who have genuine significant visual field loss.

Note: SRTA-Standard and SRTA-Fast test results will display false negative and false positive errors as percentages, not as fractions.

Fluctuation values

The fluctuation value is an option that can be used with the Full Threshold and FastPac strategies. Fluctuation is not measured when using either of the SRTA strategies. When fluctuation is turned on, the threshold is measured twice at 10 pre-selected points. The HFA II then calculates a fluctuation value on the basis of the differences between the first and second measurements at each of the 10 points. This value is an index of how reliable a patient's responses were during the test.

A patient who is very consistent will have a low fluctuation value, while a patient whose responses vary significantly will have a high value. All fluctuation values significantly outside the normal limits will be flagged on the printout with p values, e.g. $p < 0.01$.

The fluctuation option will add about 10% to the test time. When test results are analyzed with STATPAC, the fluctuation value is used in the calculation of CPSD, one of the four global indices. If the fluctuation is turned off, the CPSD will not be calculated. A discussion of p values, STATPAC and global indices can be found in Section 7.

A high fluctuation value may be the first sign of glaucomatous field loss in patients who are otherwise reliable subjects. It is also associated with established field loss in reliable subjects. On the other hand, a high fluctuation value may simply indicate that the patient was inattentive or did not understand the test.



STATPAC™ Analysis & Printing Results **7**

Introduction to STATPAC Analysis	7-2
Threshold Test Printout Formats	7-4
STA Printout Formats	7-21
Blue-Yellow Printout Formats	7-23
Printing Current Threshold Test Results	7-25
Screening Printout Formats	7-26
Printing Current Screening Test Results	7-27
Printing Previously Saved Test Results	7-28
Grayscale Symbols	7-30
Remote Printer Access	7-30

Humphrey Field Analyzer II printouts provide important information both in diagnosis and continued care. They document a patient's current visual field status as well as changes in sensitivity over time. Coupled with Humphrey's STATPAC software, HEA II printouts provide access to sophisticated statistical analysis of visual field results.

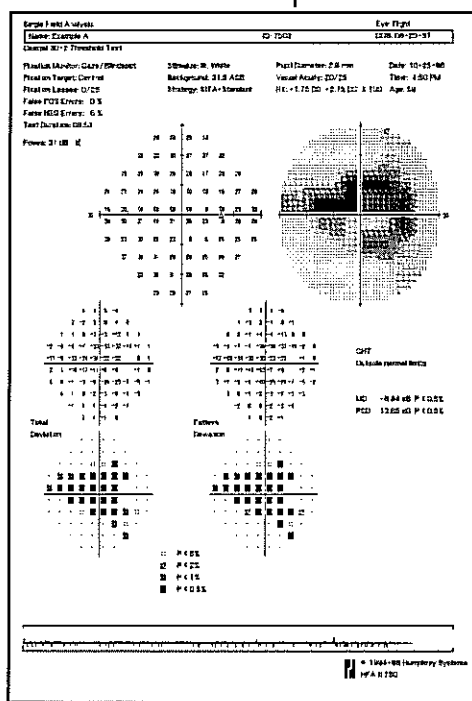

Section 7 describes the available print formats and how to generate printouts both immediately after testing and from stored files. After reading this section you will be able to answer the following questions:

- What parameters must be used to get a STATPAC analysis for a white stimulus test? For Blue-Yellow testing?
- How do I print an Overview printout?
- How do I change the baseline visual fields when using the Glaucoma Change Probability Analysis?
- What should I do if a printer stops printing while I am using the HEA II?
- How are Change Analysis box plots determined?

INTRODUCTION TO STATPAC ANALYSIS

The Humphrey Field Analyzer II's statistical software, STATPAC, provides immediate expert system analysis of threshold visual field test results. With STATPAC you can analyze test results at the time of examination, store test results and analyze them at your convenience, or recall previously stored tests to analyze for comparative purposes.

STATPAC includes several exclusive features to help you judge visual field change.

- Using results from a single test, STATPAC can point out suspicious areas that otherwise might not be evident until subsequent tests were done.
- STATPAC can identify areas that look suspicious but which, in fact, compare favorably with normals data.
- Using results from a series of tests, STATPAC provides a highly sensitive and informative analysis of changes in the patient's visual field over time.

Performing a STATPAC analysis

If you intend to run a STATPAC analysis, always take two important steps during testing:

1. Make sure that the patient's name and date of birth are entered exactly as they were recorded on previous tests. Use the RECALL PATIENT DATA button as described in Section 3: "Recalling Patient Data" to reduce patient data errors.
2. Save the test results to disk (hard drive and/or floppy disk).

These steps will avoid errors when using printouts that require multiple files for the same patient. Also, because STATPAC uses an age-adjusted model, the analysis cannot be performed properly unless the patient's date of birth is provided.

STATPAC threshold formats

STATPAC offers statistical analysis and printouts in several formats: Single Field Analysis, Overview, Change Analysis, and Glaucoma Change Probability Analysis.

The **Single Field Analysis**, as its name implies, analyzes the results of a single threshold test. This is the default printout which provides the most information for a given test.

The **Overview** presents the results of up to sixteen (16) tests for convenient comparison. You may view multiple test results per page for easier analysis.

The **Change Analysis** compares up to sixteen (16) tests and analyzes indices of change in the patient's field over time, flagging significant indicators for your attention.

The **Glaucoma Change Probability Analysis** highlights changes from a baseline which are larger than the inter-test variability typically found in stable glaucoma patients.

STATPAC test parameters

STATPAC will analyze tests that fall within the parameters listed below:

Table 7.1: STATPAC Parameters for White-on-White Perimetry

Type of test:	Threshold
Test pattern:	Central 10-2, 24-2, 30-2
Test strategy:	SRTA-Standard, SRTA-Fast, Full Threshold, FastPac
Stimulus color:	White
Stimulus size:	Size III
Fixation target:	Any
Foveal threshold:	On or Off
Fluctuation test:	On or Off (SRTA tests automatically set to Off)
Test Speed:	Normal or Slow

The full range of STATPAC analysis may be used with all Central 24-2 and 30-2 threshold test results. For Central 10-2 test results, STATPAC produces a Single Field Analysis or an Overview showing up to sixteen (16) tests results; the Change Analysis and Glaucoma Change Probability Analysis are not available. The Glaucoma Change Probability Analysis and Glaucoma Hemifield Test (GHT) are not available with tests using the FastPac strategy.

The parameters needed for STATPAC analysis of Blue-Yellow test results are listed below. Single Field Analysis and Overview printouts are available. The GHT is not available with FastPac tests.

Table 7.2: STATPAC Parameters for Blue-Yellow Perimetry

Type of test:	Threshold
Test pattern:	Central 24-2, 30-2
Test strategy:	Full Threshold, FastPac
Stimulus color:	Blue
Stimulus size:	Size V
Fixation target:	Any
Foveal threshold:	On or Off
Fluctuation test:	On or Off
Test Speed:	Normal or Slow

THRESHOLD TEST PRINTOUT FORMATS

Until this point, the User's Guide has focused on the use and operation of the HFA II. In attempting to explain the information provided on printouts, however, we must enter the realm of interpretation of field results.

Reliability indices

Humphrey Field Analyzer printouts have always included reliability indices to help you determine the reliability of the patient's responses in interpreting test results. These indices include fixation losses, false positive errors, and false negative errors. Now, Gaze Tracking can also be used for reliability information.

The reliability indices for each test appear on the Single Field Analysis, Overview, Glaucoma Change Probability Analysis, and Three-in-One printout. For Full Threshold and FastPac test strategies, the HFA II prints "XX" after scores that fall outside the reliability limits used in the normative database. In addition, STATPAC printouts include the message, "LOW RELIABILITY", in such cases. For SITA-Standard and SITA-Fast tests, the "XX" is not printed after high numbers of false positive or false negative errors, but is printed after fixation losses of 20% or more.

For Full Threshold and FastPac tests, false positive errors, false negative errors, and fixation losses are printed as a ratio, such as "3/10". The first number represents the number of errors committed, while the second number represents the number of times the instrument checked for each of these errors. In SITA-Standard and SITA-Fast tests, fixation losses are also printed as a ratio, but false negative and false positive errors are printed as a percentage, such as "25%".

The visual fields used in developing STATPAC for the Full Threshold and FastPac strategies were those of subjects whose reliability indices were within certain limits. Test results showing fixation loss scores of 20% or more and false positive or false negative errors of 33% or more were excluded as unreliable. The significance limits thus derived were more restrictive than they would have been had unreliable test results not been excluded.

Thus, clinical results having poor reliability but for which the STATPAC analysis is normal may well be normal. Results showing poor reliability and for which the STATPAC analysis is outside normal limits require careful analysis. Utilize the gaze tracking graph to help determine how steady patient fixation was during the length of the test.

If the only "XX" on a test result applies to fixation losses and you are sure the patient was fixating well, the problem may have been poor blind spot positioning rather than poor patient reliability. High false negative response rates are commonly seen in abnormal fields produced by completely reliable patients. On the other hand, test results may indeed be unreliable already at false positive rates lower than the level required to generate the "XX" symbol.

Foveal threshold

If you used the foveal threshold option when the test was run, the HFA II will print the measured value just below the test time. When the patient's foveal threshold is significantly depressed ($p < 5\%$), a probability symbol will appear next to the value shown. This symbol is identical to those used for the probability plots and indicates the deviation from age normal. See the following discussions on Total and Pattern deviations for details.

The single field analysis printout

The Single Field Analysis is based on the results of a single central threshold test. The top of the page presents patient data, test reliability indices, and the test results in the grayscale and numeric formats. The information that STATPAC adds is found in the lower half of the page.

Patient Data
 Test Parameters
 Reliability Indices
 Numeric (dB) Results
 Grayscale Results
 Probability Symbols
 Gaze Graph

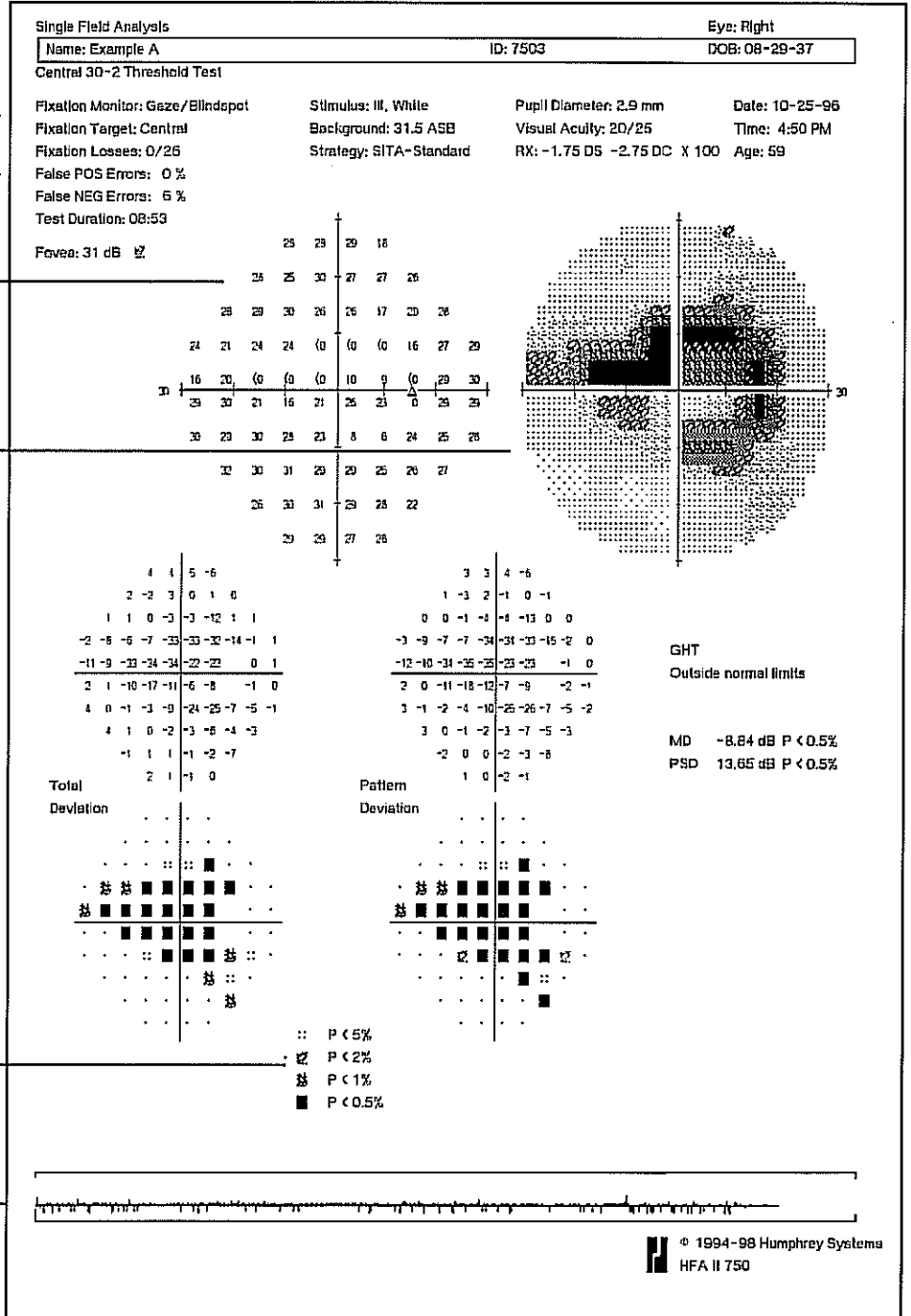

Figure 7.1: The Single Field Analysis Printout

The glaucoma hemifield test

On 24-2 and 30-2 tests taken using the SITA-Standard, SITA-Fast or Full Threshold strategies, the Glaucoma Hemifield Test (GHT) evaluates five zones in the superior field and compares these zones to their mirror image zones in the inferior field. The GHT evaluates the severity of disturbed points in each zone pair, relative to its normative database, and prints one of these messages: GHT WITHIN NORMAL LIMITS, OUTSIDE NORMAL LIMITS, or BORDERLINE. The Glaucoma Hemifield Test is not available with tests using FastPac.

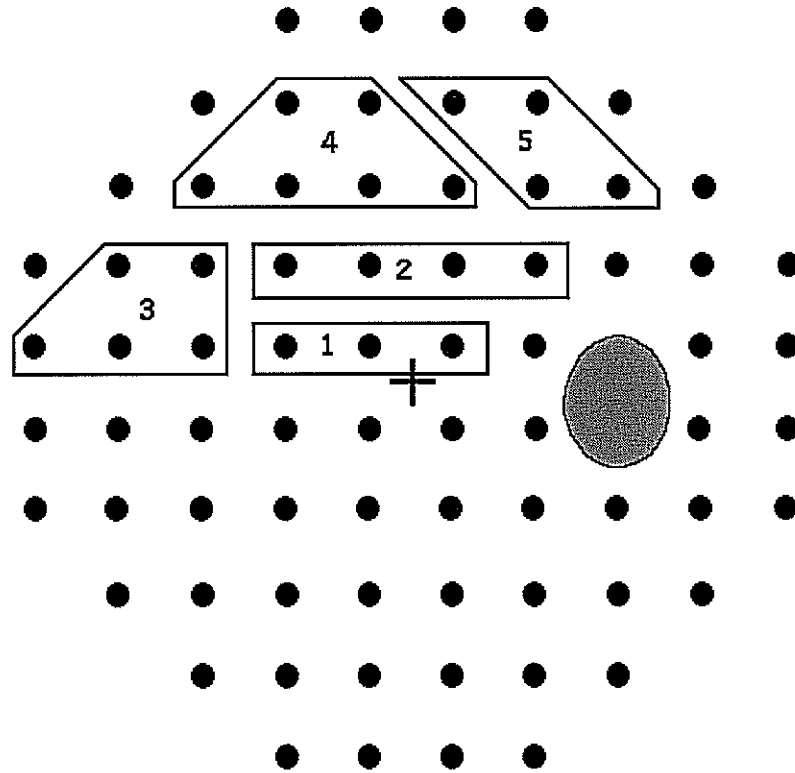

Figure 7.2: Superior Field Zones Used in the Glaucoma Hemifield Test

The primary aim of the GHT is to identify localized visual field loss occurring in a pattern typical of that seen in glaucoma. It also indicates when test results show that the overall field is severely depressed or shows suspiciously high sensitivity. The message GENERAL REDUCTION OF SENSITIVITY is printed whenever the field is depressed to a level seen in fewer than 0.5% of the normal population in the patient's age bracket.

Similarly, when the comparison indicates abnormally high sensitivity (a level found in fewer than 0.5% of the normal population of that age), the message ABNORMALLY HIGH SENSITIVITY appears. The GHT does not flag the case where only a few points are abnormally high, but it will catch cases where the overall pattern of patient responses indicates a patient who is overly anxious to push the button. It is always useful to check the false positive and false negative errors, and fixation losses as well.

Note: The GHT is not intended for use in patients being evaluated for diseases other than glaucoma.

Total deviation plots

On the left in the lower half of the Single Field Analysis printout is a pair of plots, one above the other, labeled Total Deviation. The numeric values in the upper portion of these plots represent the difference in decibels (dB) between the patient's test results and the age-corrected normal values at each tested point in the visual field.

The lower total deviation plot, called a probability plot, translates the values in the upper plot into shaded symbols which indicate the statistical significance of each decibel deviation. These are explained in the legend labeled Probability Symbols. The darker the symbol the less likely it is that the field is normal in that location (although the likelihood of abnormality also depends upon the actual prevalence of disease in the patient population). For instance, a totally black square indicates that the deviation from normal found at that point location occurs in fewer than 0.5% of normal subjects. Notice that this probability statement is made on a point-by-point basis, allowing the practitioner to read the results like an isopter plot or graytone.

Pattern deviation plots

To the right of the total deviation plots in the Single Field Analysis printout are two additional plots, labeled Pattern Deviation. These are similar to the total deviation plots, except that here STATPAC has adjusted the analysis of the test results for any changes in the height of the measured hill of vision caused, for example, by cataracts or small pupils. Similarly, STATPAC corrects for any patients who are "supernormal", adjusting the expected hill of vision upward by the appropriate amount and thereby making the analysis more sensitive to localized scotomas.

Thus, the numeric Pattern Deviation plot shows the deviation in decibels from the age-corrected normal values, adjusted for any shift in overall sensitivity. The pattern deviation probability plot indicates the statistical significance of the result at each point. Again, the darker the symbol the more significant the deviation from the normal threshold value.

Global indices

A short table labeled Global Indices appears on the far right side of the page. Here STATPAC has made some calculations to provide overall guidelines to help the practitioner assess the field results as a whole rather than on the point-by-point basis shown in the Total Deviation and Pattern Deviation plots. The four global indices are calculated from deviations in the age-corrected normals data. The "p" (probability) values for the global indices, discussed below, do not need to be corrected again for age.

Mean Deviation (MD) is the average elevation or depression of the patient's overall field compared to the normal reference field. If the deviation is significantly outside the population norms, a "p" value is given. For example, if $p < 2\%$, this means that fewer than 2% of the normal population shows an MD larger than that found in this test. Categories for p values are $p < 10\%$, $p < 5\%$, $p < 2\%$, $p < 1\%$, and $p < 0.5\%$.

A significant MD may indicate that the patient has an overall depression, or that there is significant loss in one part of the field and not in others. MD is best interpreted in relation to the Total and Pattern Deviation charts.

PSD stands for Pattern Standard Deviation. PSD is a measurement of the degree to which the shape of the patient's measured field departs from the normal, age-corrected reference field. A low PSD indicates a smooth hill of vision. A high PSD indicates an irregular hill and may be due either to variability in patient response or to actual field irregularities. The statistical significance for PSD is indicated using the same categories for "p" as with the mean deviation.

SF is Short-term Fluctuation, which the Humphrey Field Analyzer measures during the test. It is an index of the consistency of the patient's responses during the test and is obtained by testing twice at ten (10) pre-selected points. Categories for p values are the same as for MD. The SRTA testing strategies do not calculate SF. Therefore, only MD and PSD are available when using SRTA-Standard or SRTA-Fast.

CPSD stands for Corrected Pattern Standard Deviation. It is a measure of how much the total shape of the patient's hill of vision deviates from the shape of the hill of vision normal for the patient's age, corrected for intra-test variability (SF). The hill of vision may be irregular in shape because of unreliable patient responses, because of actual field losses, or a combination of the two factors. Categories for "p" values are the same as for MD.

In calculating CPSD, STATPAC attempts to remove the effects of patient variability and to present only the irregularity caused by actual field loss. CPSD depends on both PSD and SF and is, therefore, not available unless the fluctuation option remains on during testing.

The overview printout

The Overview printout can show the results of up to sixteen (16) tests. It condenses the information shown in a Single Field Analysis and makes it easy to review a series of tests. The tests are automatically printed in chronological order. The patient's name, date of birth, type of test, and eye tested appear at the top of the page. Results from 30-2 and 24-2 tests may be presented in the same printout. STATPAC does not combine 10-2 with any other test patterns.

The Overview presents the results of each test in four formats: Graytone, Numeric, Total Deviation probability plot, and Pattern Deviation probability plot. The date of the test appears to the upper-left of the Graytone, and the visual acuity and pupil size are printed to the upper-right of the Pattern Deviation probability plot. The GHT is printed to the right of the test date. The foveal threshold, fixation losses, false negative errors, false positive errors, and global indices appear below the test results. The legend to the probability symbols appear at the bottom of the printout.

You may print Overviews of 24-2, 30-2, and 10-2 tests after using non-STATPAC stimulus sizes I, II, IV, or V and non-STATPAC colors Blue or Red. In these cases graytone, numeric thresholds, and defect depth are printed. No probability plots are available. You can also print Overviews of Blue-Yellow test results.

Overview printouts cannot consist of a mixture of tests run with different stimulus sizes or colors. Blue-Yellow tests may not be mixed with any white background test (including tests run with a blue color stimulus). Blue-Yellow Overview printouts are labeled as such.

The change analysis printout

Like the Overview printout, the Change Analysis printout shows analyses of up to sixteen (16) test results on one sheet. In this case, STATPAC gives you an analytical summary of changes in the patient's visual field from the time of the earliest test you have included in the summary to the time of the most recent test included.

STATPAC presents the Change Analysis in the form of a box plot analysis of test results, a summary of four global indices, and a linear regression analysis of Mean Deviation. The indices are the same four presented in the Single Field Analysis, but this time they are plotted over time to indicate changes in the patient's visual field.

The box plot

Box plots are helpful in making a quick determination about the nature and extent of visual field changes over time. The box plot is a modified histogram that gives a five-number summary of the test results. It displays a concise summary of the Total Deviation decibel value for each test, showing the median, the two extreme values and the 15th and 85th percentile deviations.

The summary is made up of the differences at each tested point between the patient's measured field and the STATPAC age-corrected reference field. STATPAC plots the extreme values of these differences (the 100th and zero percentile, or top and bottom end points of the line shown at (b) in Figure 7.4, the median difference (the three dark lines inside the box shown at (a), and the 85th and 15th percentile differences (the top and bottom of the box).

Look at the box plot in Figures 7.4 and 7.5. The four things to note are:

1. The overall shape of the box, how elongated or compact it is.
2. The location of the three dark lines inside the box that indicate the median (a).
3. The top and bottom end points of the line along which the box lies (b).
4. Where the patient's box is plotted against the normal scale on the left of the printout.

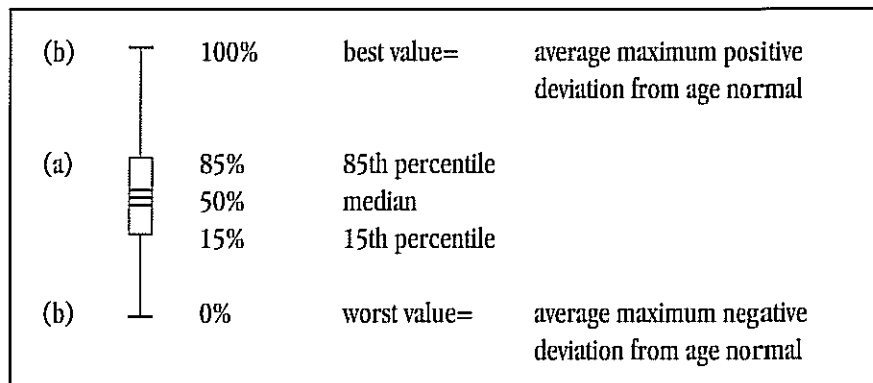

Figure 7.4: The Box Plot

To facilitate interpreting your patient's field results, a "normal" box is presented to the left of the patient's scale (see Figure 7.5). This is the mean of the boxes derived from the normals data on which the STATPAC model is based.

Box Plot or Histogram

Summary of Global Indices

Linear Regression

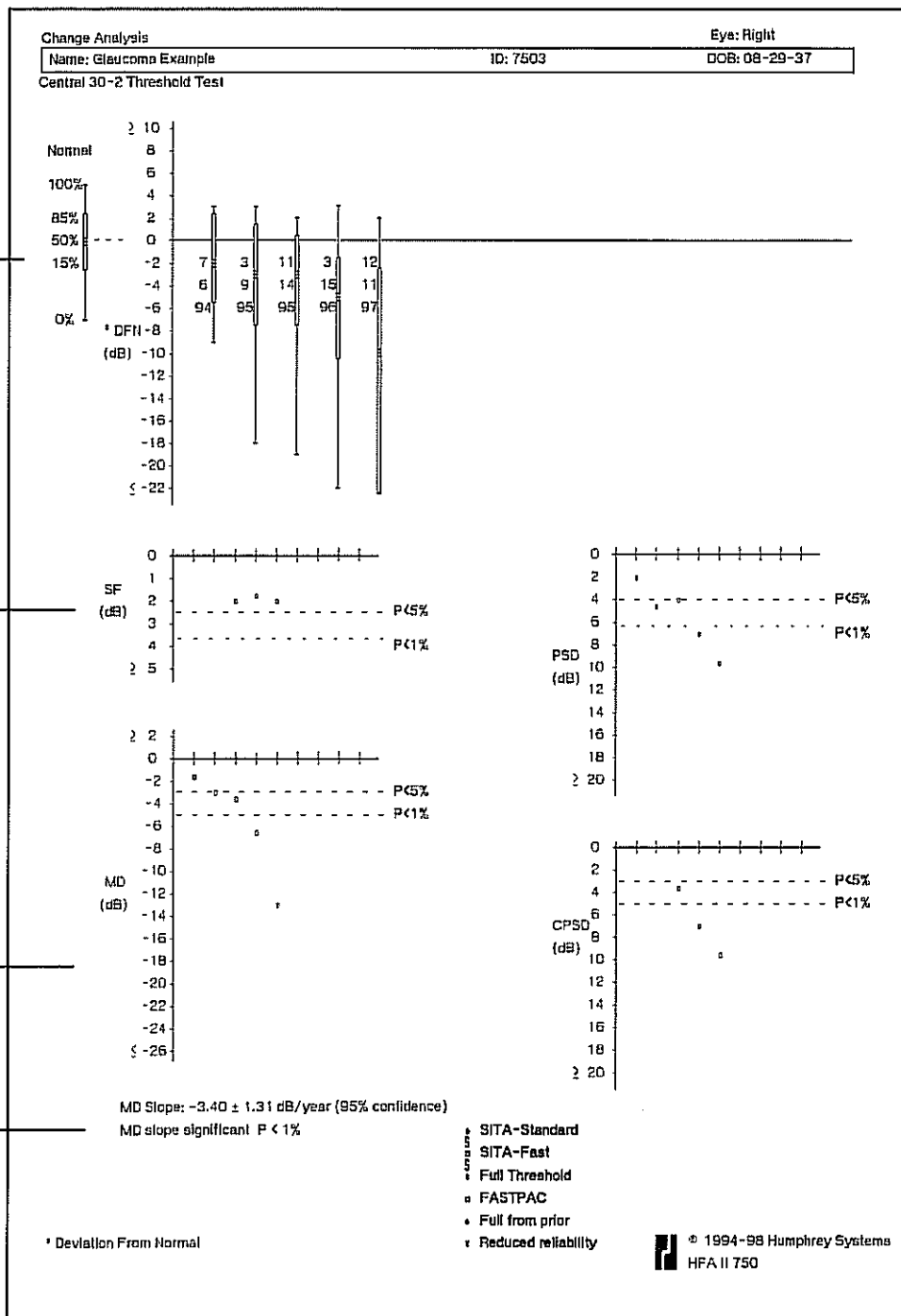

Figure 7.5: The Change Analysis Printout

In cases where the patient is suffering from a cataract, the visual field is depressed more or less evenly. The only change from test to test and from the normal box plot is a general depression over time. Therefore, the shape of the box plot remains fairly normal, but the whole symbol is moved downward on the graph.

A visual field with a deep scotoma covering a small number of points will result in a box plot in which the box is more or less normal and there is a long tail. When a scotoma deepens over time, the length of the tail increases.

If the scotoma enlarges to involve more than 15% of the points tested, the lower limit of the box will be further depressed, and depending on the extent and gravity of the field loss, the boxes may be very elongated.

The box plot section of the Change Analysis printout gives the dates of the tests included in the analyses. Change Analysis is available for the 24-2 and 30-2, as well as combinations of 24-2 and 30-2 tests, but not for the 10-2 pattern. If 24-2 and 30-2 tests are mixed in the Change Analysis printout, global indices are calculated only on the 24-2 portion of the 30-2 test results.

The lower half of the Change Analysis printout displays summaries of the global indices MD (Mean Deviation), PSD (Pattern Standard Deviation), SF (Short-term Fluctuation), and CPSD (Corrected Pattern Standard Deviation) for the tests shown in the box plot.

The summary results are presented chronologically and in the same order as in the box plots. Thus, test dates may be taken from the box plot.

To facilitate interpretation, the $p < 5\%$ and $p < 1\%$ limits for the normal population are shown as dashed reference lines. If, for example, the symbol indicating a test appears above the 5% line, the index value on the test is not significant at the 5% level. If it falls below the 5% line, the index value is significant at the 5% level. Similarly, if the symbol falls below the 1% line, the index value is significant at the 1% level; that is, less than 1% of the normal population has an index value as large as or larger than that found in the test.

If five or more fields are analyzed on a Change Analysis printout, and all test results to be analyzed were run with the same strategy, STATPAC will automatically perform a linear regression analysis of mean deviation (MD). One of two messages, MD SLOPE NOT SIGNIFICANT or MD SLOPE SIGNIFICANT, will be printed below the MD plot when a linear regression analysis has been performed. The calculated slope of MD in decibels per year and a tolerance for that slope, expressed as a p value, will also be printed.

A "significant" message means that it is likely that mean deviation has changed in the direction of the estimated slope, and the lower the "p" value, the more likely it is. However, it remains for the clinician to establish whether this indication on the test results is caused by progressive field loss or by other factors.

Change analysis
summary of global indices

Linear regression

A linear regression analysis tests the hypothesis that a slope is zero; that is, that there have been no changes in the patient's visual field. If this hypothesis is rejected after analysis at the $p > 5\%$ level, the slope is said to be significant and the analysis continues at the 1% and 0.1% levels of significance. The result is then displayed as being significant at $p < 5\%$, $p < 1\%$, or $p < 0.1\%$.

Not only the significance level but also the magnitude of the slope is important. If, for example, the MD slope is -3.6 dB per year, plus or minus 0.9, this means that there is a 95% confidence level that the slope is between -2.7 and -4.5 dB per year. The slope is significant at a "p" level of less than 1%. This is a slope magnitude on the order of more than thirty times the rate of change due to aging in the normal population. A slope of only one or two tenths of a decibel per year would be viewed with considerably less concern, as it is similar in magnitude to the age correction which has already been applied to the data.

If the hypothesis that the slope is zero, that is, that there has been no change in the patient's visual field, is not rejected, the message NOT SIGNIFICANT appears and STATPAC show a "p" value of $p > 5\%$. This indicates that the slope was not significant at the largest "p" value STATPAC is programmed to consider, 5%.

The larger the number of tests analyzed, the more easily the small changes in MD are detected. A low number of observations involves a higher risk that the analysis will fail to detect a deterioration over time. This is the reason that STATPAC will not perform an analysis on fewer than five test results.

The application of the linear regression analysis means that the following assumptions have been made:

1. The true MD changes linearly with time.
2. The differences between the measured and the true MD are independent, and identically and normally distributed.

Note: For the Change Analysis printout, you can mix tests done using the FastPac strategy with those using Full Threshold. Because some of the STATPAC limits are slightly different depending on whether FastPac was used or not, the significance lines for plotting PSD, SF, and CPSD will not be on the printout if you are analyzing a series of FastPac and non-FastPac tests. Significance lines, however, will be displayed for Mean Deviation. When STRA tests are included, the normal box plot is not displayed for comparison (see Figure 7.6).

The Change Analysis program will also perform a regression analysis of mean deviation over time when a series of tests using mixed strategies are used. When strategies are mixed, a minimum of six test results are required for regression analysis; when all tests have used the same test strategy, only five results are required. When tests are mixed with STRA results, or STRA-Standard or STRA-Fast are mixed with each other, no linear regression will be performed. Mixture of strategies is not recommended, however, as the relationship of results across strategies is complex and difficult to quantify.

No Normal Box Plot

Summary of Global Indices (No p Values)

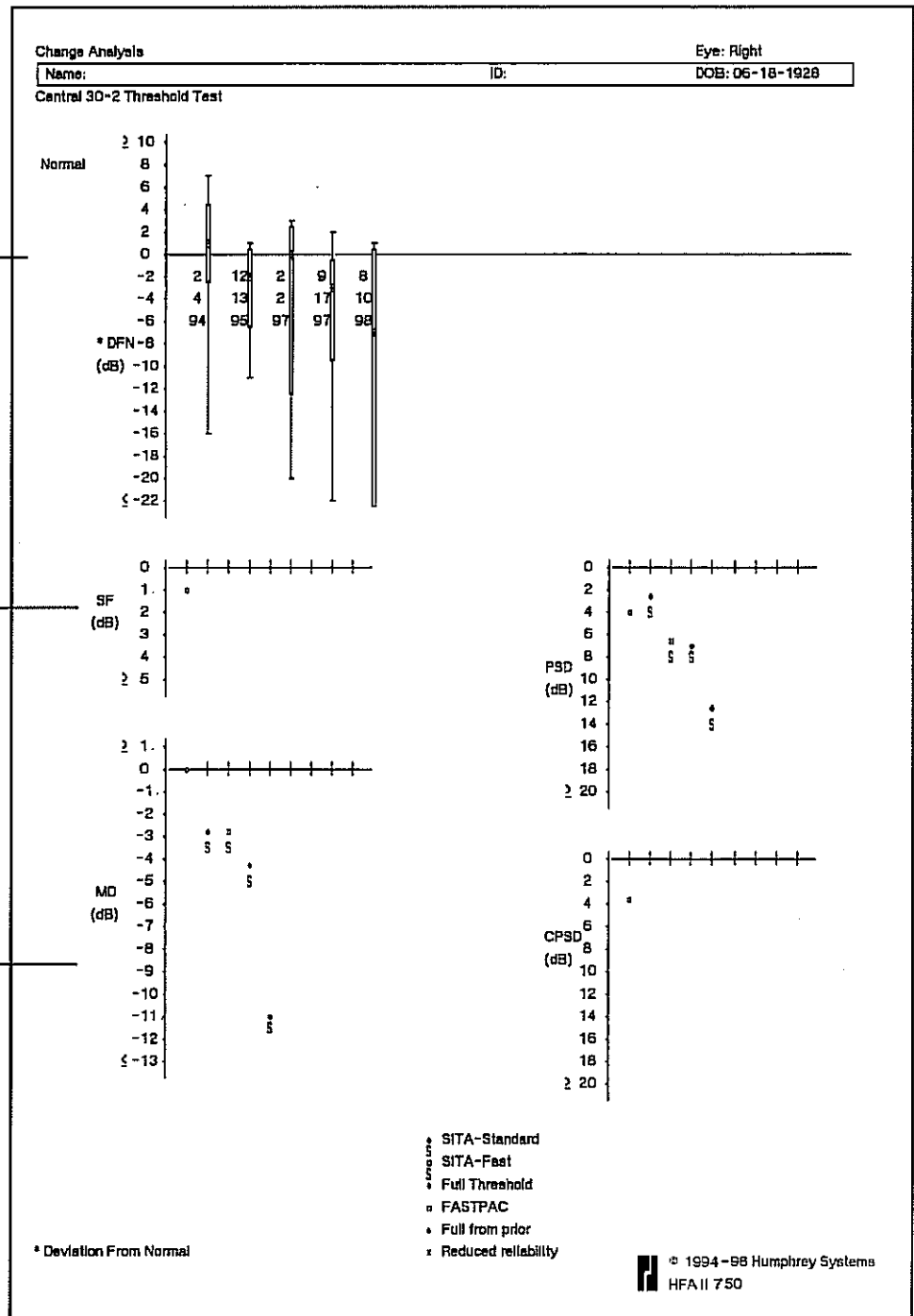

Figure 7.6: A Mixed Change Analysis Printout with SITA Tests Included

Note: The normal box plot and the p values for the global indices are not displayed. In addition, no linear regression information is presented when SITA tests are included.

The glaucoma change probability analysis printout

The Glaucoma Change Probability Analysis is designed to facilitate interpretation of Central 30-2 and 24-2 threshold test results in patients with suspect or manifest glaucoma. It is intended to allow maximum use of available test results. This analysis is particularly useful in determining change over time, that is, in separating random variation from true change.

The Glaucoma Change Probability Analysis works from baseline data for the individual patient to create change probability maps and to calculate significance limits for measured changes in mean deviation. Because the global indices (MD, SE, PSD, and CPSD) are not necessarily sensitive to important localized changes, the Glaucoma Change Probability Analysis offers point-by-point significance limits. This allows analysis of smaller areas of the visible field defect and enables early detection of change.

The Glaucoma Change Probability plots identify those locations in the visual field which have changed by more than what would be expected simply due to normal variability. The significance limits for this analysis were obtained by testing a large group of glaucoma patients four times in the course of a month. Normal variability in these patients was found to depend on the depth of the original defect at baseline, the location in the visual field, and the overall Mean Deviation of the visual field. Points changing from baseline by more than the empirical significance limits are highlighted with small triangles.

In general, the Glaucoma Change Probability Analysis will use the average of the first two selected tests as a baseline and all subsequent tests as follow-up. There are two exceptions:

1. If only two tests are selected, the first will be used as the baseline and the second as follow-up.
2. If the mean deviation of the first test falls significantly below the regression line of those of the other tests ($p < 5\%$), and five or more tests are to be analyzed, STATPAC will discard the first test, use the second and third tests to calculate the patient's baseline, and analyze the subsequent tests as follow-up tests.

Note: Baseline tests should be representative of the actual baseline status of the patient. Baselines established from tests in which the patient was obviously inattentive, inexperienced, or too eager to press the response button can lead to false positive or false negative conclusions upon follow-up. Create a new pair of baseline tests if significant change has occurred (cataract surgery, for example).

The Glaucoma Change Probability Analysis was designed to allow comparison of a series of follow-up tests with the baseline findings in order to detect and confirm changes in the visual field. Prudence requires that changes detected in one follow-up test be confirmed in at least one additional test before medical therapy is significantly changed or surgery is ordered.

The glaucoma change probability printout (Figure 7.7 and 7.8) includes the patient information that appears on other STATPAC printouts. Two data presentations (graytone and total deviation plot) for the baseline tests are printed on the upper left section of the printout. A plot of the Mean Deviation (MD) for each test plus the linear regression analysis of mean deviation, which is discussed below, occupy the upper right section of the printout. The first column on the left of the printout contains the graytone presentation of test results. The total deviation plot appears in the second column. These are the only two data presentations given

for the two baseline tests. Just above them is printed a message indicating whether the results of the glaucoma hemifield test (GHT) were within normal limits, outside normal limits, or borderline. The mean deviation from normal for this test is printed between the graytone and the total deviation plot.

For each of up to fourteen (14) follow-up tests there are two more test result analyses: the change from baseline plot (third column), and its associated probability map (fourth column). The change from baseline plot in the third column subtracts the follow-up test result from the baseline and indicates changes at each tested point in dB notation. If, for example, a point is indicated with -6, this means that the tested point was 6 dB lower than the baseline for the same point. A zero (0) means no change from baseline. All results use age-corrected values over the follow-up period.

The change probability map

The change probability map in the fourth column gives the statistical significance of the decibel changes shown in the change from baseline plot. It compares the changes between the baseline and follow-up fields to the inter-test variability typical of stable glaucoma patients and then shows a plot of point locations which have changed significantly. A solid triangle identifies a degree of deterioration found less than 5% of the time at that location in medically stable glaucoma patients, that is, deterioration significant at the 5% level. An open triangle identifies improvement significant at the 5% level. Points not changing by a significant amount are indicated by a single, solid dot.

An X signifies that the program was unable to determine whether the encountered change was significant or not. This occurs mainly with deepening field defects which were already quite deep at baseline. The finite amount of empirical data available to us and the practical limitation of the maximum attainable brightness of the instrument made it difficult to obtain exact significance limits for deterioration in points which are already highly depressed.

The very same reasons, finite amount of data and limits to the maximum brightness, also make it difficult to determine change with certainty in fields where the mean deviation from normal exceeds -15. In addition, variability is extremely large in highly disturbed fields ($MD < -15$). Since variability increases with increasing MD in this range, STATPAC analysis can only verify stability, not deterioration or improvement. STATPAC printouts carry the message AVERAGE MEAN DEVIATION OF ALL TESTS TOO LOW when the average MD of baseline and follow-up tests is lower than -15.

Change in mean deviation

STATPAC also evaluates the significance of change in mean deviation over time. The objective is to highlight those clinical cases where the MD changes by more than is typically observed in stable glaucoma patients. The amount of change in decibels is printed under the message MD Change. If the MD change is significant at the 10%, 5%, or 2.5% level, that p value is printed along with a solid triangle to indicate degradation or an open triangle to indicate improvement. If the amount of change is not judged to be significant, the words "Not Significant" follow the decibel value.

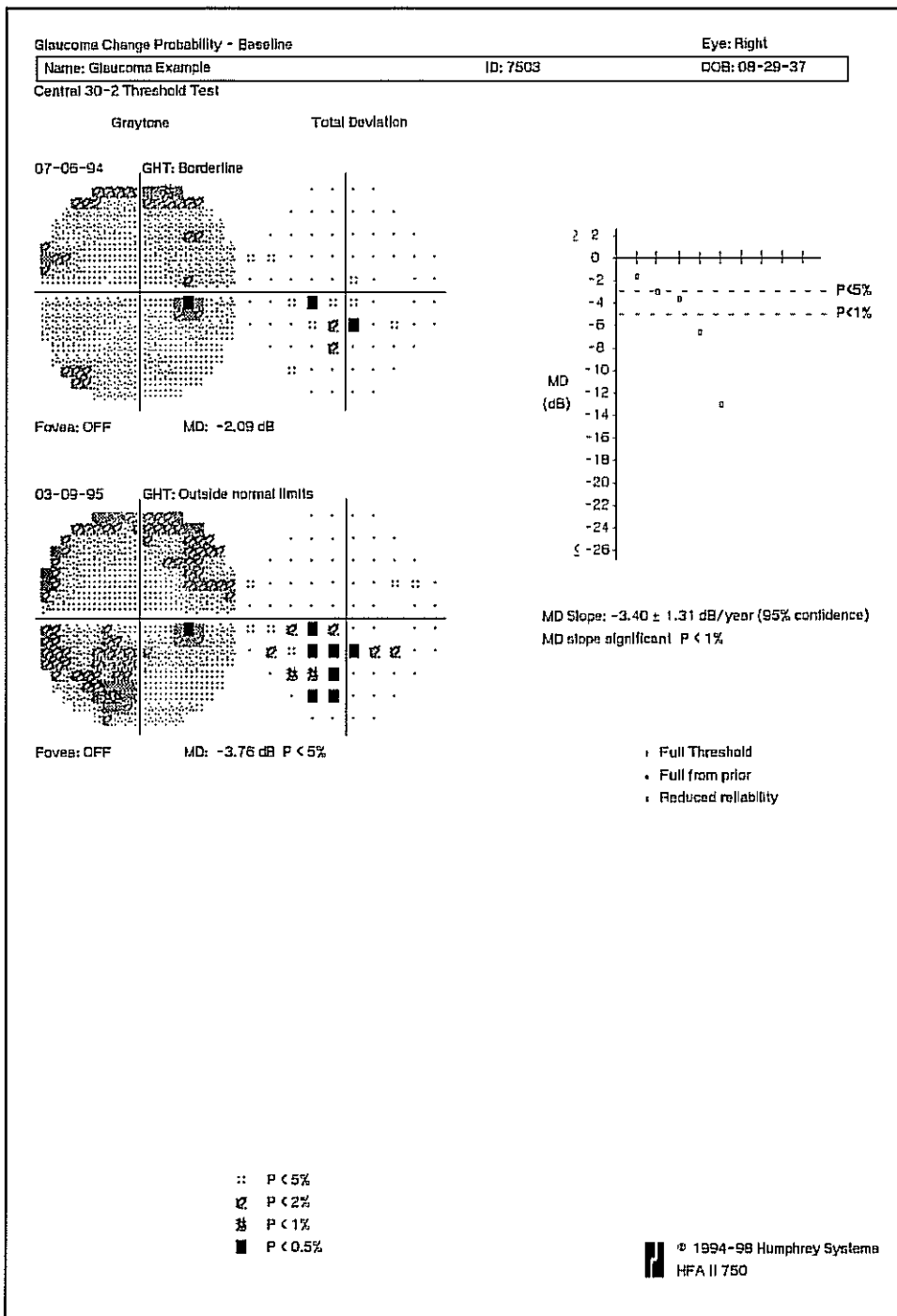

Figure 7.7: The Glaucoma Change Probability - Baseline

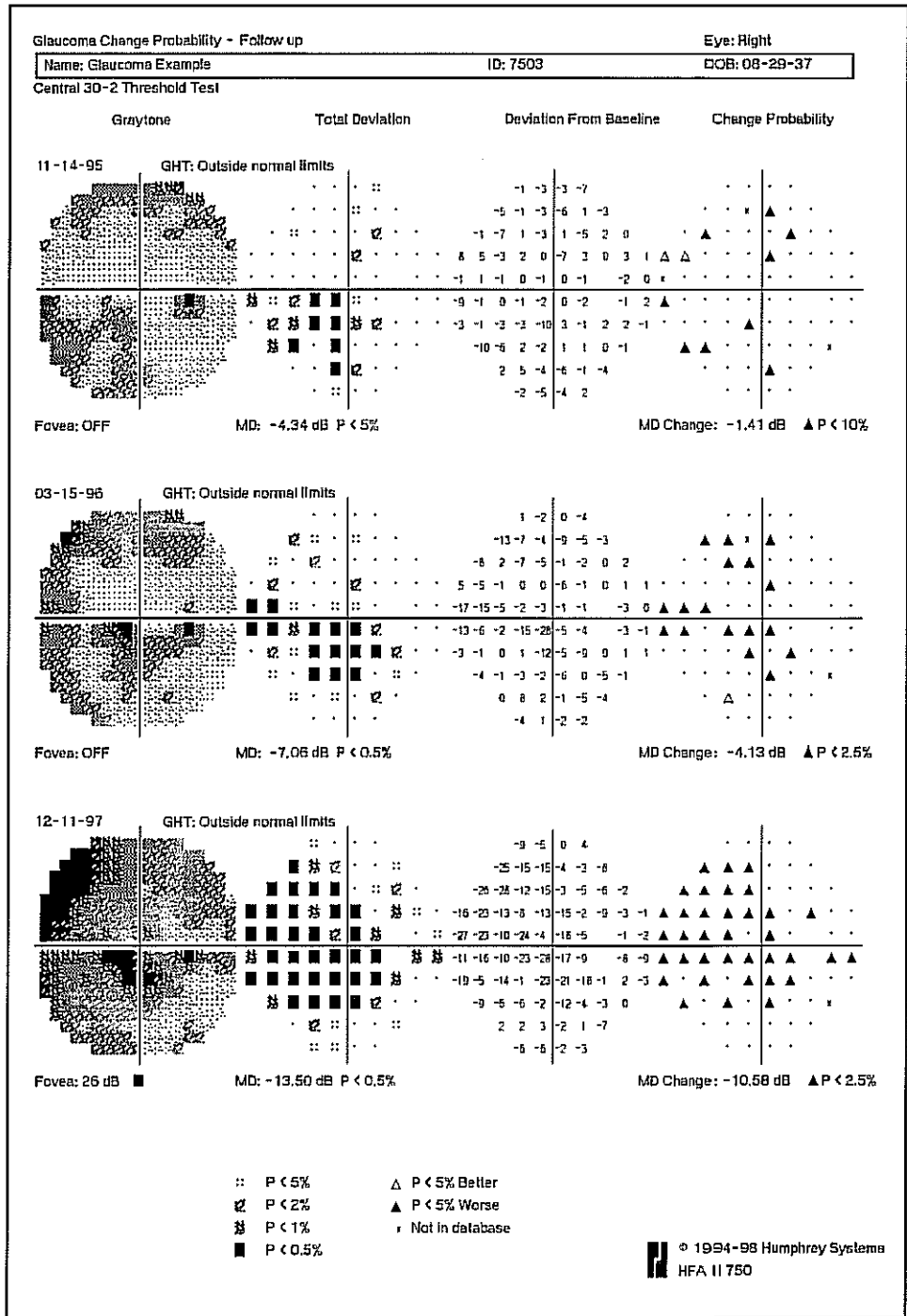

Figure 7.8: The Glaucoma Change Probability - Follow Up

Modified linear regression analysis

The STATPAC linear regression of mean deviation, accompanied by the message "MD Slope Significant" or "Not Significant" appears on the Glaucoma Change Probability Analysis printout as well as the Change Analysis.

STATPAC modifies this regression analysis whenever marked learning effects are present. When at least five tests are chosen for analysis, the modified STATPAC regression analysis discards the first test result in a series if its mean deviation is significantly out of line with and worse than the trend shown in later tests ($p < 5\%$). If the modified method is used, the value shown is labeled Modified MD Slope.

When STATPAC determines that a first test result should be omitted from its calculations to correct for learning effects, it also automatically discards this test result from the calculation of the probability plots.

On statistics and probability

When considering the probability statements in this statistical package, it is important to be conscious of what they do and do not mean. They are an aid to interpretation, not a diagnosis. The doctor's judgement is still the most important element in determining the clinical significance of perimetric findings.

The probability statements are based on the distribution seen in the normal population. Saying that less than 5% of the normal population deviates from the norm by a certain amount means just that and not more. It does not mean that there is only a 5% chance that the result is normal.

The positive predictive rate depends, of course, on the prevalence of defective fields in the population studied. The probability that a given result is abnormal depends on the relative prevalence in the population of defects caused by disease versus the prevalence of the same field "defect" in normals. If a certain field result is seen 5% of the time in normals, and similar glaucomatous field defects are seen in 0.5% of the population, then the result is ten times as likely to be associated with normality as with disease.

Certainly one should also be aware that some patients commonly seen in a clinical practice may not meet the criteria of normality (for example, visual acuity) which had to be applied in creating a normals data base. These patients may fall outside normal limits established in this statistical package for reasons other than field loss, such as cataracts.

A note of caution

Rules of common sense must be applied when using STATPAC. This statistical package represents an attempt to aid the practitioner in making medical decisions. There will be situations where it will not give the proper analysis either because of its own limitations or because it was applied to inappropriate data. Obviously, the practitioner must bear the ultimate responsibility for all decisions and must use STATPAC with its limitations in mind. In cases of uncertainty, consultation with sub-specialists is often the prudent course.

Three-in-One printout

If you have selected a threshold test pattern or test parameters that do **not** meet the criteria for STATPAC analysis, results are presented on the Three-in-One printout. The Three-in-One printout includes a graytone, numeric, and defect depth presentation of the results of a single test on one page. The numbers which appear outside each quadrant of the numeric grid are called "quad totals" and represent a summation of the threshold values determined in each quadrant. These numbers which, even in normals will not be the same for each quadrant, can be useful in comparing several tests on the same patient over time. This format is available for 10-2, 24-2, 30-2 central field tests, and for the peripheral 60-4 test.

The nasal step threshold test printout differs from other Three-in-One printouts. Only threshold and defect depth data are shown. All graytone data is omitted.

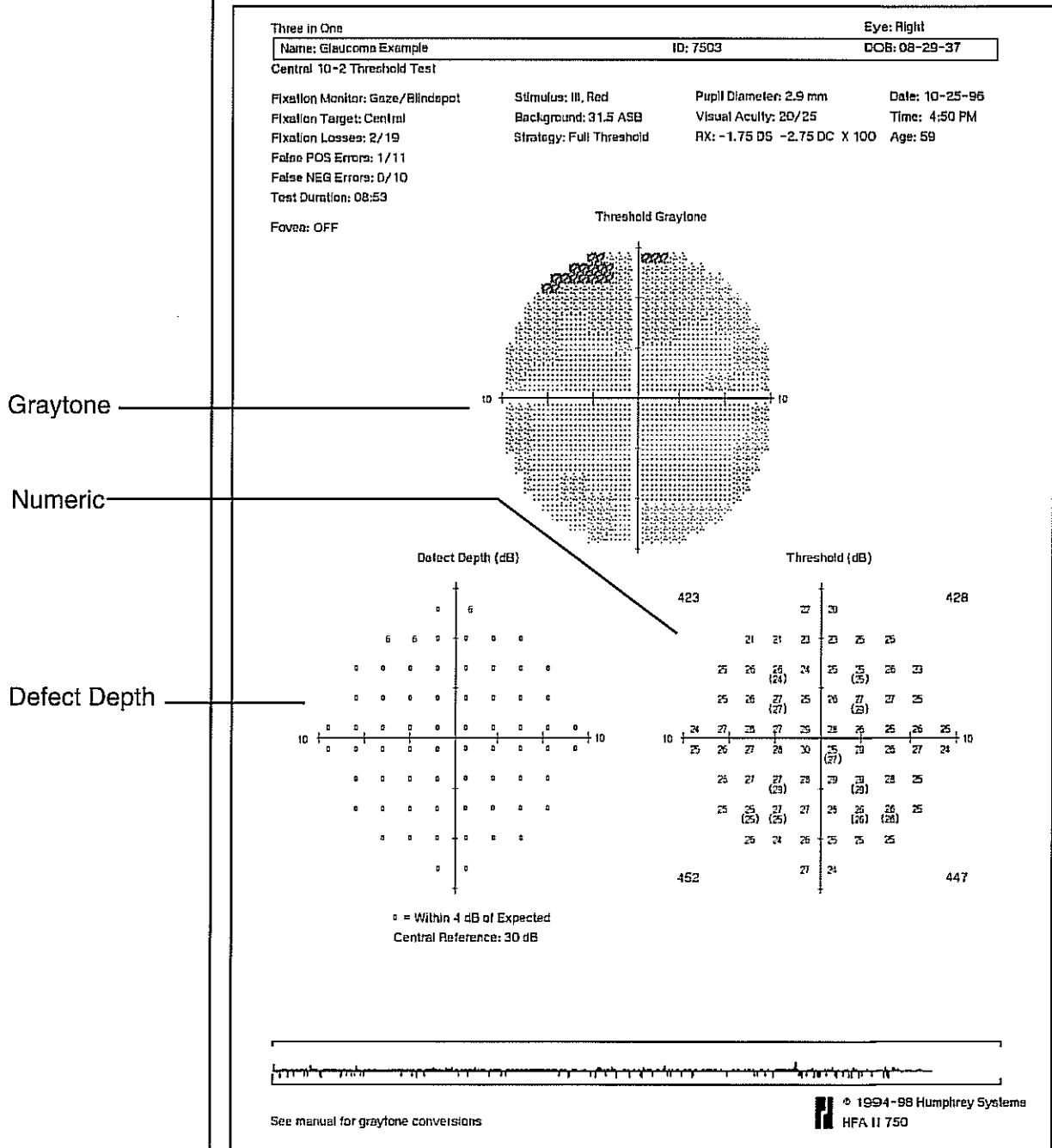

Figure 7.9: Three-in-One Printout

SITA PRINTOUT FORMATS

Tests performed using the SITA strategy can be displayed in the Single Field Analysis format or combined with other testing strategies in the Overview or Change Analysis printouts. Both SITA-Standard and SITA-Fast tests will display the Total Deviation probability plot, the Glaucoma Hemifield Test (GHT) status, and will include the global indices for Mean Deviation (MD) and Pattern Standard Deviation (PSD). No numerical values for Short-term Fluctuation (SF) will be displayed and because no SF value is determined, no Corrected Pattern Standard Deviation (CPSD) value will be displayed. The reliability indices False Positive (FP) and False Negative (FN) are displayed as percentages, not as fractions.

Note: The STATPAC analysis of SITA 10-2 threshold patterns will not include 0.5% limits on the Total or Pattern Deviation plots. In addition, no 0.5% probability limit will be displayed for the global indices MD and PSD.

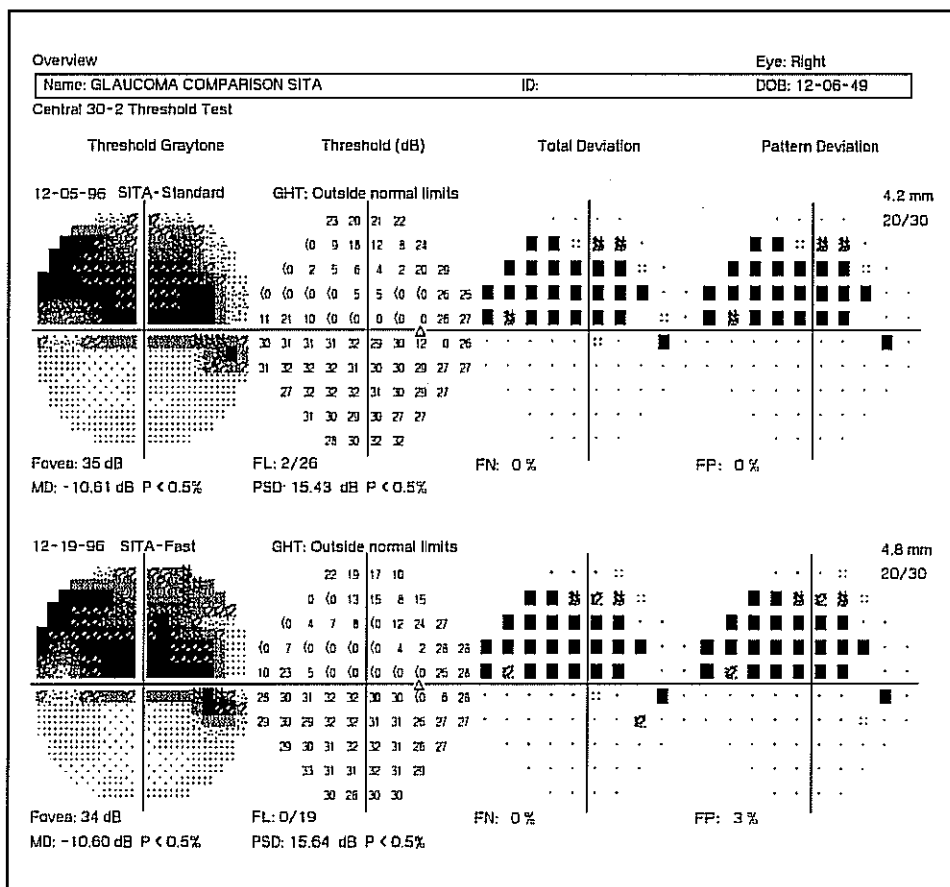

Figure 7.10: An Example of the Overview Printout Showing Both SITA-Standard and SITA-Fast Test Results for the Same Patient

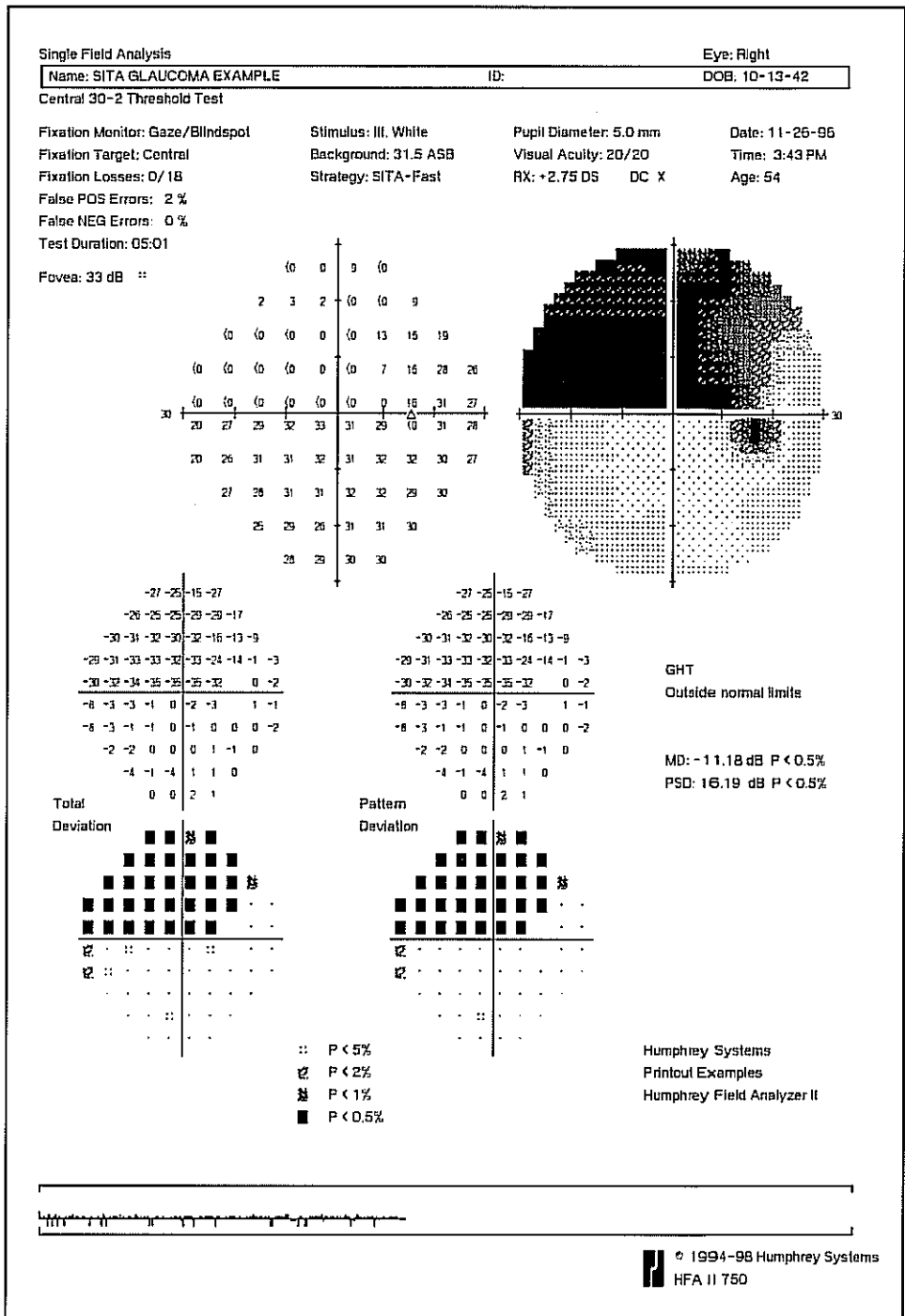

Figure 7.11: An Example of a Single Field Analysis Printout for SITA

BLUE-YELLOW
PRINTOUT FORMATS

Single field analysis printout

Blue-Yellow printouts use the same grayscale as White-on-White testing. The grayscale will look significantly darker with Blue-Yellow testing in most cases. This is because Blue-Yellow testing normally generates lower threshold values than does White-on-White testing. It is particularly important to pay most attention to the STATPAC probability plots rather than the traditional grayscale. If interpreted using standard White-on-White perimetry rules, the grayscale may lead to misinterpretation of test results.

The Single Field Analysis printout is modified slightly with STATPAC for Blue-Yellow. A box outlines the global indices and the words "BLUE-YELLOW" in the lower right portion of the printout. This helps to differentiate it from the White-on-White Single Field Analysis printout (see Figure 7.12).

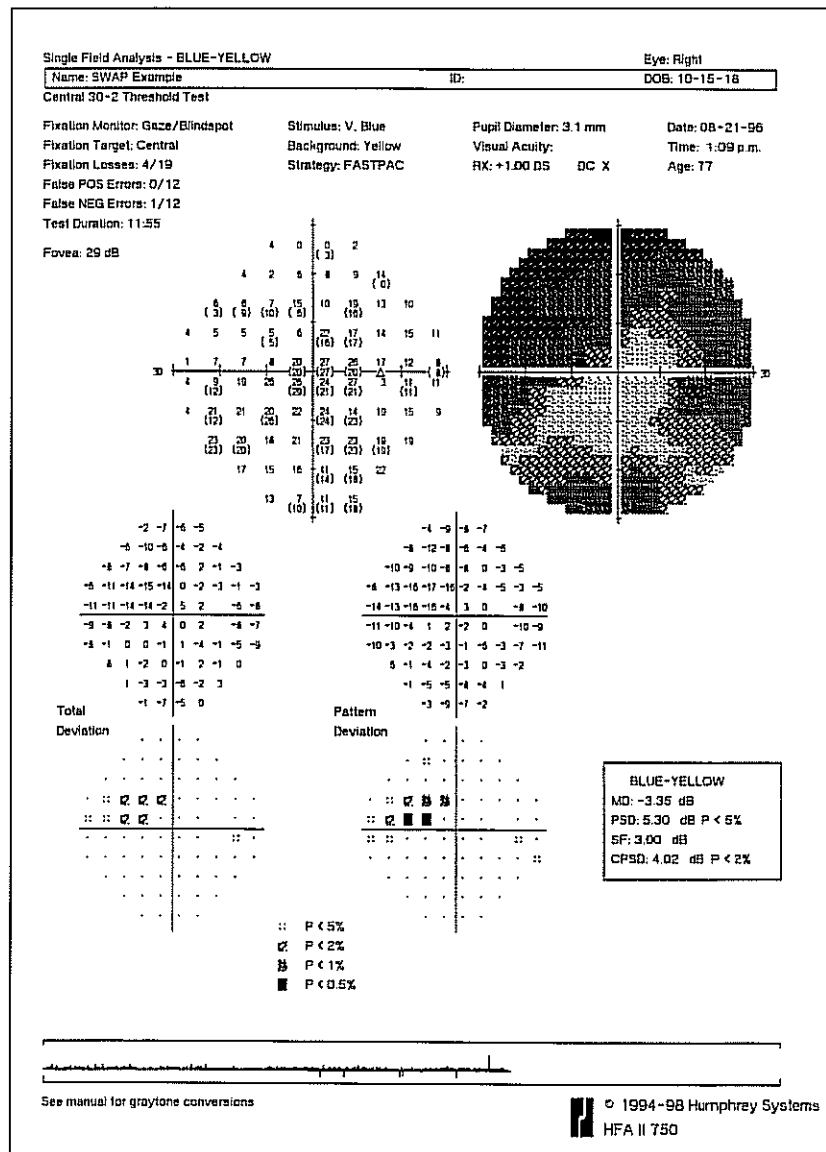

Figure 7.12: The Single Field Analysis Printout for Blue-Yellow (SWAP)

PRINTING CURRENT THRESHOLD TEST RESULTS

At the end of a threshold test, you can print the results in any or all of the STATPAC formats that apply to your test parameters, as well as in the Three-in-One format.

To print results, select the *PRINT FUNCTIONS* icon. The printout selection menu will appear with print options. If both eyes have just been tested, it is possible to choose different printouts for right and left eye; the selections need not be the same for both.

If STATPAC criteria have been met, the print menu will display with Single Field Analysis highlighted. For additional formats, touch the box next to the desired selection. An "X" appears within the box of all selected printouts. Touching the box a second time clears your selection.



When you have made your printout selection(s), choose **PRINT ALL SELECTED ITEMS**. The information has now been sent to the printer; you can proceed with your next command immediately. To leave the Printout Selection screen without printing, press the *UNDO* icon.

To print a single field analysis of current test results

1. Make sure the patient's name and date of birth are entered correctly, then save the results on disk.
2. From the Test Complete screen, select the *PRINT FUNCTIONS* icon. This takes you to the Printout Selection screen where Single Field Analysis is highlighted.
3. Choose **PRINT ALL SELECTED ITEMS**.

To print an overview, change analysis, or glaucoma change probability of current test results

1. Make sure the patient's name and date of birth are entered correctly, then save the results on disk.
2. From the Test Complete screen, select the *PRINT FUNCTIONS* icon. This takes you to the printout selection menu where Single Field Analysis is highlighted.
3. De-select Single Field Analysis if you do not want it to print. Select either Overview, Change Analysis, Glaucoma Change Probability Analysis, or all three.
4. Choose **PRINT ALL SELECTED ITEMS**.
5. The HFA II displays all the files on the current disk that match the patient's name and date of birth. If there are more than sixteen such files, the most recent sixteen, including the test results you just saved, will be highlighted on the screen.
6. Deselect those files you do not want to be included in the printout, then choose **PROCEED**.

SCREENING PRINTOUT FORMATS

It is the test strategy used in each screening test that determines the format of the printed test results (see Table 7.3).

Table 7.3: Screening Printout Formats: All Screening Test Patterns

Strategy	Format Description
Two Zone	Points seen O Points missed ■
Three Zone	Points seen O Relative defect X Absolute defect ■
Quantify Defects	Points seen O Numbers (in dB) show depth of defect

When you have tested both the right and left eyes for the same patient, you have the option of printing a single screening test per page (referred to as "Screening Test" on printout selection menu), or a combination of the right and left eye on one page (referred to as "Both Eyes"). To obtain the screening printout for both eyes, screening tests may be central or peripheral but not full field patterns (see Example 7.14). The printout of both eyes is also known as the "O. U. Printout".

The Quantify Defects Full Field screening test is printed on two pages. The first page consists of the Full Field printout. The second page is an enhanced view of the Central 30 degrees, allowing for easier reading of the central portion of the printout. If there are no defects quantified in the Central 30 degrees, the printout will only be one page long. The printout will be in the full field format.

The type of test and test parameters are printed at the top of the printout along with the patient data, test date and test time. Like threshold test printouts, screening printouts include reliability indices to help you determine the reliability of the patient's responses.

When a screening test uses the Threshold Related testing mode, the central (and peripheral) reference level values are determined from patient responses and appear on the printout and test screen. When the Age Corrected mode is used, the central (and peripheral) reference levels display values based on the patient's age.

Reading screening test
printouts

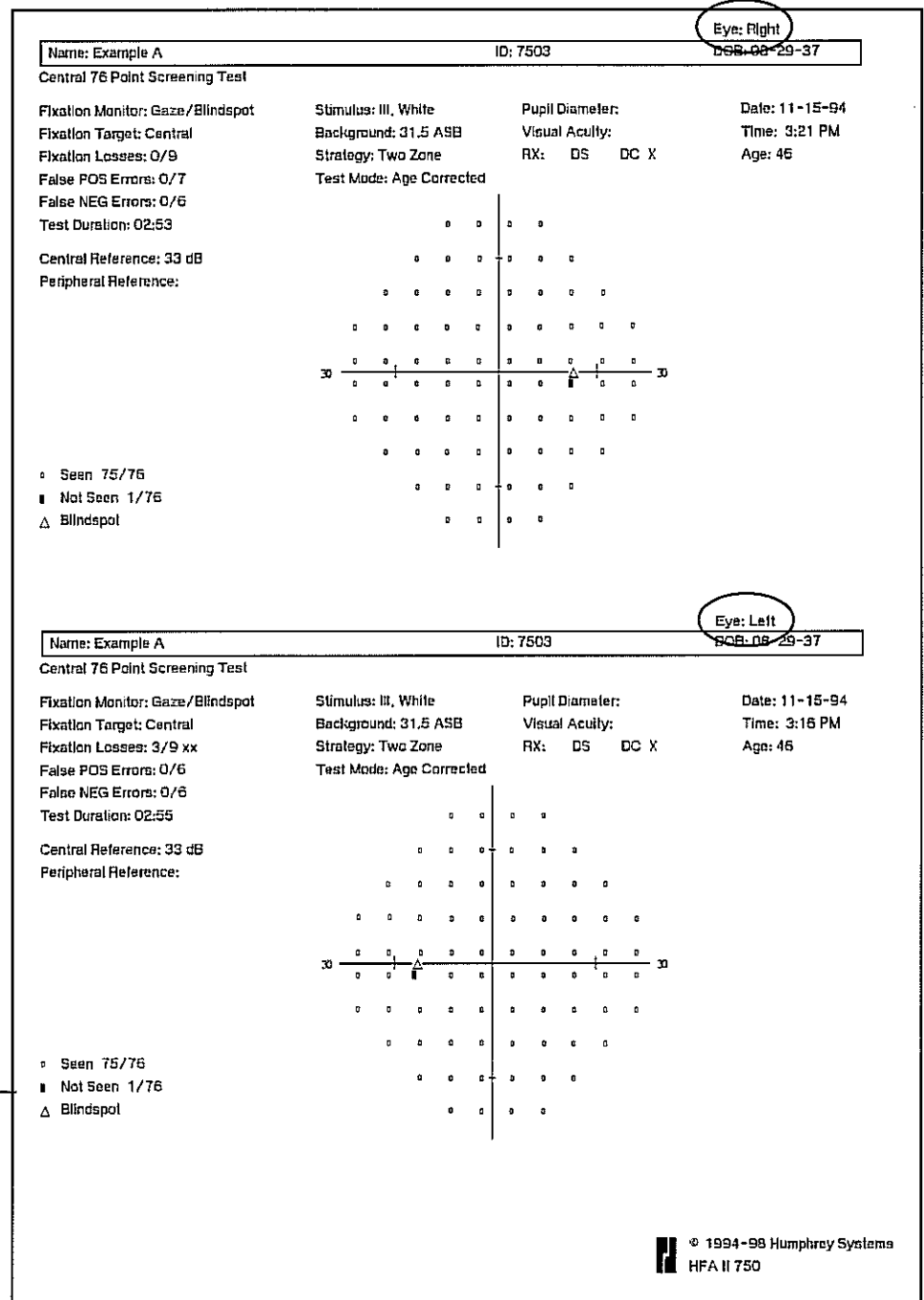

Screening Printout Symbols

Figure 7.14: Screening Printout Showing Results for Both Eyes (The O. U. Printout)

PRINTING CURRENT SCREENING TEST RESULTS

At the end of a screening test you can print the results for the one eye immediately, or you can wait until the second eye has been tested and print both results on one page.

1. Make any additions or corrections to patient data.
2. From the test complete screen, select the *PRINT FUNCTIONS* icon. This takes you to the printout selection menu.
3. Select the format(s) for one or both eyes, then choose *PRINT ALL SELECTED ITEMS*.

PRINTING PREVIOUSLY SAVED TEST RESULTS

Printing test results stored
on disk

You can obtain printouts at any time convenient to you, if you store the results on disk. You begin the process by selecting the *PRINT FUNCTIONS* icon from any screen where the *PRINT FUNCTIONS* icon is active. First you choose the Source and press PROCEED. This will retrieve the File Directory. After selecting the test or tests from the directory, the program will either start printing or present additional options, depending on the type of tests (screening or threshold) selected. Refer to the chart below for more details.

If you select:

The print program:

- | | |
|---|--|
| 1. One screening test
(right or left eye) | Starts printing immediately. The print format depends on the screening strategy used. |
| 2. Two or more tests for
different patients | Starts printing immediately. Threshold tests are printed using the Single Field Analysis format, where appropriate; otherwise the printout is the Three-in-One format. Screening tests are printed one page per eye. |
| 3. One threshold test | Presents the printout selection menu. If you select Single Field Analysis or the Three-in-One format, the program starts printing immediately.

If you select Overview, Change Analysis, or Glaucoma Change Probability, the program presents the file directory in order for you to verify the tests you wish to include. |
| 4. Two threshold tests for the same
patient, one for right eye and
one for left eye | Same as #3. |
| 5. Two screening tests for the
same patient, one for right eye
and one for left eye | Presents the printout selection menu.
Screening tests are printed one per page or both on one page. |

Note: If you want to combine 24-2 and 30-2 results on one printout, STATPAC will analyze only the Central 24 degrees. If you want an analysis of the Central 30 degrees, do not combine 24-2 and 30-2 results for these printouts. The 10-2 test cannot be used in conjunction with 24-2 or 30-2 tests, and is not available in the Glaucoma Change Probability format.

Printing from recall last test

The HFA II holds in temporary memory the last right eye and left eye tested (they need not be for the same patient) until the instrument is powered off, at which time the memory is cleared.

1. From the Main Menu screen, select **RECALL LAST TEST**.
2. Select the test eye (right or left) to proceed, or **CANCEL**.
3. Follow the instructions outlined above for printing current test results.

Printing from view test

You can print any file you have retrieved through the View Test feature.

1. From the Main Menu screen, select the **FILE FUNCTIONS** icon.
2. Select **VIEW TEST**.
3. Designate the Source and Directory Order, then press **PROCEED**.
4. Select the test you want to retrieve.
5. Choose **PROCEED** to display the test results.
6. Follow the instructions outlined previously for printing current test results.

Printing delay

Whenever the File Directory Box is open (see example), printing will not occur.

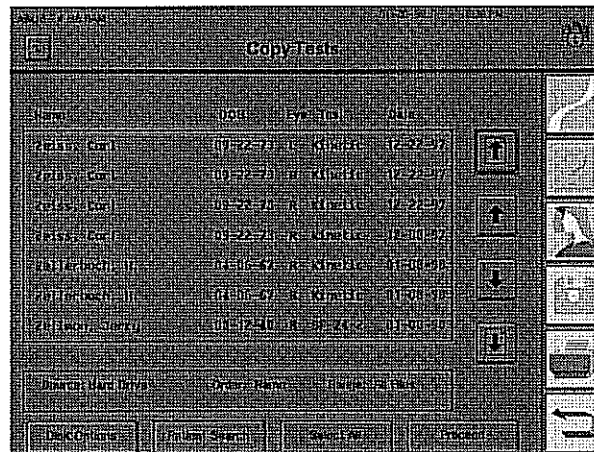

If you have already started a printing function, and a File Directory box is on the screen, finish your selection or press the **MAIN MENU** icon in order to allow printing to continue.

GRAYSCALE SYMBOLS

The grayscale representation of the patient's visual field provides an immediate idea of the size and depth of any field defects present. Each variation of the pattern corresponds to a 5 dB change in sensitivity. The comparative scale below (Table 7.4) shows the ten (10) grayscale patterns and relates them to decibels and apostilbs. An explanation of the relationship between these units of measurement along with conversion tables can be found in the Appendix.

Note: Blue-Yellow printouts use the same relationship between grayscale symbol and decibel values as White-on-White testing. The grayscale will look significantly darker with Blue-Yellow testing in most cases. This is because Blue-Yellow testing normally generates lower threshold values than does White-on-White testing. Note that the maximal (0 dB) stimulus in Blue-Yellow testing is 6 foot-lamberts, not 10,000 apostilbs.

SYM										
ASB	.8 - .1	2.5 - 1	8 - 3.2	25 - 10	79 - 32	251 - 100	794 - 316	2512 - 1000	7943 - 3162	2 - 1000
DB	41 50	36 40	31 35	26 30	21 25	16 20	11 15	6 10	1 5	0 50

Table 7.4: The Grayscale Shades Found on HFA II Printouts and Their Numerical Equivalents in Apostilbs (ASB) and Decibels (dB).

REMOTE PRINTER ACCESS

It is possible to link the HFA II to a compatible printer without using cables. The same printer can be shared with other devices or computers in your office. One system, known as GoPrint™, allows HFA II owners to communicate to any HFA II-compatible printer within a certain distance, regardless of whether or not the instrument and the printer are in the same room. One "Computer-GoPrint" device is connected to the HFA II, while a second "Printer-GoPrint" device is connected to your printer. GoPrint is produced by the AeroComm company. Check your computer or electronics store for details and availability of a GoPrint system.

Perform the following steps to set up a GoPrint system:

1. Insert the connector cable of the Computer-GoPrint into the parallel printer port on the back of the HFA II.
2. Insert the connector cable of the Printer-GoPrint into the printer port of your printer.
3. Plug in both GoPrint power supplies.
4. Turn on both the HFA II and the printer.
5. Make sure that the appropriate printer type (e.g. Printrex, LaserJet) is designated on your HFA II under PRINTER on the System Setup screen.

File Functions

File Functions Menu	8-2
Retrieving the File Directory	8-4
Selecting Tests from the Directory	8-6
Performing File Functions	8-11
External 5.25" Floppy Disk Drive	8-18
Organizing Patient Files	8-22

At the end of every test you have the opportunity to save the test data. When you elect to save, the test results and associated patient data are stored with all previously stored tests on either an internal hard disk, a removable floppy disk, or both. This packet of stored information is called a *file*, and for each right eye and each left eye tested there is a separate file.

Once saved, tests can be retrieved, edited, copied, moved to another storage medium, or deleted. These activities are part of the File Functions menu. The entire collection of tests on a hard disk or floppy disk is referred to as a *database*. **It is absolutely essential to make backup copies of all of your databases regularly in case they become lost or damaged.**

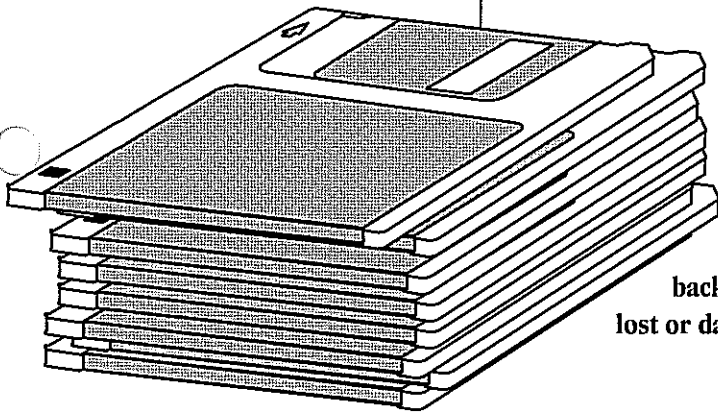

FILE FUNCTIONS MENU

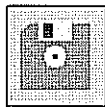

The File Functions menu lists the main activities you can perform with your stored patient data and tests. It is accessed by selecting the *FILE FUNCTIONS* icon. A more detailed explanation of each function appears below Figure 8.1.

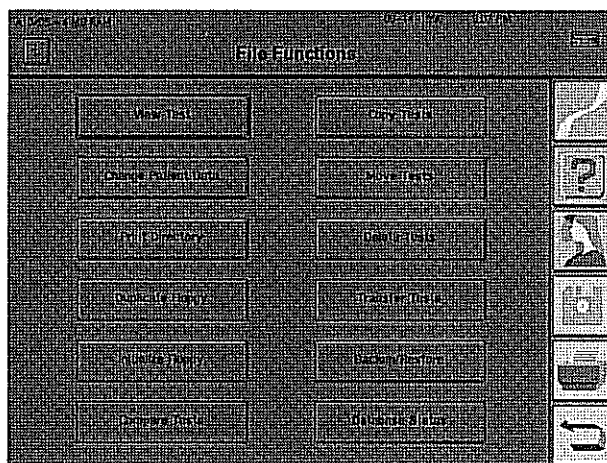
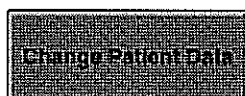

Figure 8.1: The File Functions Menu



VIEW TEST allows you to recall patient test results. Retrieving one test at a time, it displays the completed test on the screen. While results are being displayed, you can also select the *Print* icon to get a hard copy of the test results.



CHANGE PATIENT DATA is used to add or change entries on the Patient Data 1 and Patient Data 2 screens. You may choose whether changes made to patient data fields will affect the retrieved test only, or whether they will change all stored tests for that patient. You may also change an individual test date with this feature.



PRINT DIRECTORY allows you to print a directory listing the tests stored on the hard disk or on a floppy disk. You may print a directory listing of every test saved on the disk or you may designate specific tests to include in the directory printout.



You can make duplicate copies of floppy disks using the single floppy drive through **DUPLICATE FLOPPY**. This procedure copies all test data from one floppy disk to another. You can also duplicate floppy disks using any IBM PC compatible computer equipped with a 1.44 MB 3.5" floppy disk drive.



Before you can save test data to a new floppy disk, you must perform a procedure called initialization or formatting. Initializing prepares the floppy disk to record information in the format used by the Humphrey Field Analyzer. **Remember: if you initialize a disk that already contains data, all data on that disk will be erased.** You can also initialize disks using any IBM PC compatible computer.

Compare Tests

The COMPARE TESTS feature subtracts the results of two threshold tests and indicates the decibel difference at each point. This comparison is useful, for instance, for tracking the deterioration in a patient's visual field on tests for which STATPAC is not available. The results are displayed on the screen and may be printed.

Copy Tests

The COPY TESTS function copies any number of tests from one storage medium to another. Use this function when copying one or more tests from the hard disk to a floppy disk and vice versa (models 735-750), or from one floppy disk to another floppy disk (all models).

Move Tests

The MOVE TESTS function transfers tests from one storage medium to another. Unlike the Copy function, this function **deletes** the selected test(s) from the source disk at the same time that it moves them to the destination disk. Not available on model 720.

Delete Tests

The DELETE TESTS function permanently erases tests from either the hard disk or floppy disk. When deleting a single test, the test contents will be displayed on the screen before the delete action is executed. When multiple tests are chosen, they are not displayed first.

Transfer Tests

Patient tests may be transferred from an older Humphrey Field Analyzer model (the HFA I) to the HFA II via the optional external 5.25" floppy disk drive or the RS-232 serial port on each instrument by using the TRANSFER TESTS command. An IBM PC compatible cable connection (with 9 pins on one end and 25 pins on the other) is required to connect the instruments. You can transfer approximately 1,440 tests per hour at a 9600 baud rate. See "Transferring Tests Between the HFA I and HFA II" later in this section.

Back Up/Restore

(Models 735-750)

The BACKUP/RESTORE function allows you to back up or save tests stored on the hard disk to either streamer tape or floppy disks. Neither tape backup nor floppy backup allows the user to pick and choose what tests should be backed-up. The entire database will be backed-up. Use this same feature to restore information to the hard disk, if necessary. Extensive information on the BACKUP/RESTORE feature is found in Section 9.

It is important to regularly back up all of your databases to ensure that you can access all of your tests even if the originals become damaged or lost.

Notes:

1. *Backing-up tests will erase all information on the destination disk or streamer tape and replace it with the information from the source disk. Therefore, we advise rotating among multiple streamer tapes or backup disk sets.*
2. *Restoring tests from floppy disk or streamer tape will erase all information on the hard disk and will replace it with the information from the source disk or tape. Data from the streamer tape or backup floppy disks may be merged onto the hard drive to add tests from the streamer tape or backup floppy disks that do not exist on the hard drive. See Section 9: "Merge Database".*

Database Status

DATABASE STATUS gives information on the number of tests and the number of patients found on the hard disk and floppy disk databases.

RETRIEVING THE FILE DIRECTORY

Selecting a particular File Function is only the first step in accomplishing the task. The next step involves calling up the directory of tests. The directory is a list of tests contained on a specified storage medium. It is from the directory that you select the test or tests to be included in the particular File Function.

Before the directory is displayed you are asked to specify certain minimum criteria:

- Source
- Destination (where applicable)
- Directory Order

These are found on the Disk Options screen (see Figure 8.2 below).

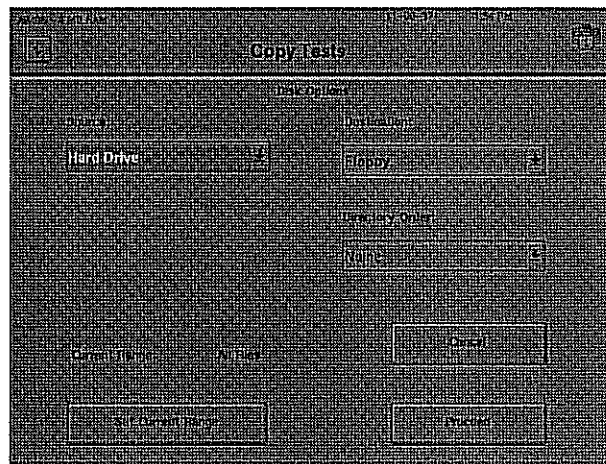

Figure 8.2: The Disk Options Screen

In order to successfully locate the desired tests, you must designate the source of the tests—the location on which they are currently stored. The primary choices are HARD DRIVE or FLOPPY. When transferring tests, HFA I SERIAL CABLE and HFA I EXTERNAL FLOPPY will also appear on the Source list. The choice of TAPE is available as an option with the RESTORE function (model 750).

The Disk Options screen includes a destination choice. Destinations include FLOPPY, HARD DRIVE and HFA I EXTERNAL FLOPPY. HFA II owners who wish to copy tests to the HFA I must use an optional 5.25" external floppy drive. Choosing the HFA I EXTERNAL FLOPPY as the Destination allows you to copy HFA II tests to an HFA I floppy disk. This special floppy drive is available through Humphrey Systems. TAPE becomes an option with BACKUP (model 750).

Note: The Source and the Destination can both be set to FLOPPY at the same time. This occurs when you want to copy data from one floppy disk to another. The HFA II will alert you to when to insert the Source disk and when to insert the Destination disk into the floppy disk drive. Be careful not to mix up the Source and Destination floppy disks. Data can be lost!

Disk options

Source:



Destination:

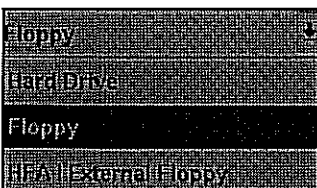

Directory order:



You may display the directory by NAME, DATE, or PATIENT. When NAME is selected (see Figure 8.5), tests are displayed alphabetically. When displayed by DATE, tests appear chronologically with the most recent test at the top of the directory. When displaying tests by PATIENT, the patients will be displayed in alphabetical order—but the individual tests for each patient *are not* displayed. Once a particular patient has been chosen, all of the tests for this patient will be displayed in the File Directory. Each test will be listed with Eye, Test Type, Date and Time of test (see Figure 8.3 and 8.4 below).

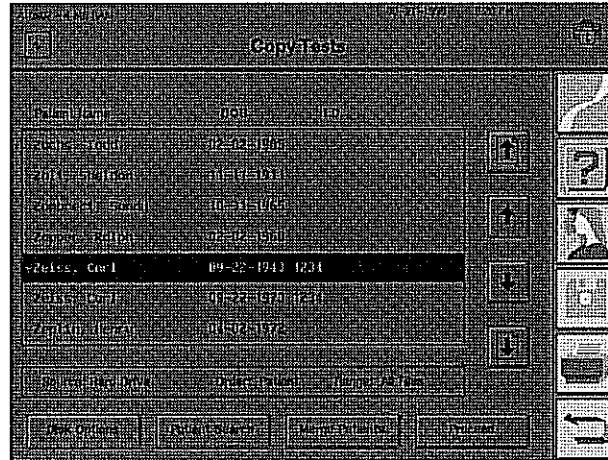

Figure 8.3: The File Directory – Sorted by Patient

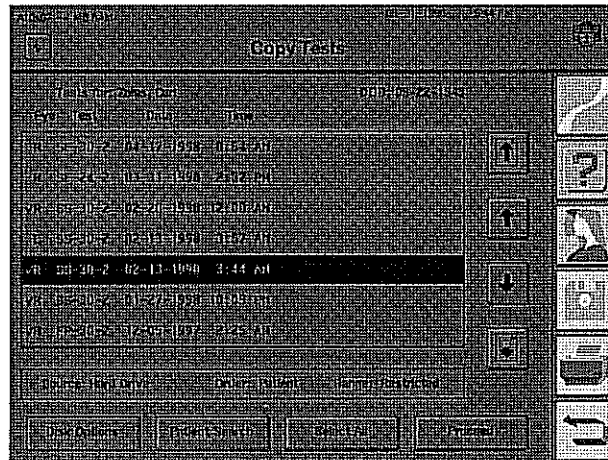

Figure 8.4: The File Directory – Single Patient Test Display

The other buttons found on the Disk Options screen include PROCEED, SET CURRENT RANGE and CANCEL. PROCEED brings up the keyboard to help in finding the patient tests. Enter enough letters on the keyboard to locate the patient. The SET CURRENT RANGE feature helps to limit the number of tests searched or helps to create a subset of tests for database functions. Additional details follow the next section. Pressing CANCEL on the Disk Options screen returns you to the File Functions menu.

SELECTING TESTS FROM THE DIRECTORY

After using the keyboard to help locate the desired patient(s), you are ready to use the file directory. First you need to select those tests to be included in the desired function. To select a test, simply touch it. A check sign (✓) appears to the left of every selected test. When copying tests, you may choose more than one test. To clear a selection, touch the test a second time.

Often the directory contains more tests than can be displayed on one screen. In fact, no more than seven tests can be shown at one time; however, you can easily move through the directory with the aid of a few command buttons.

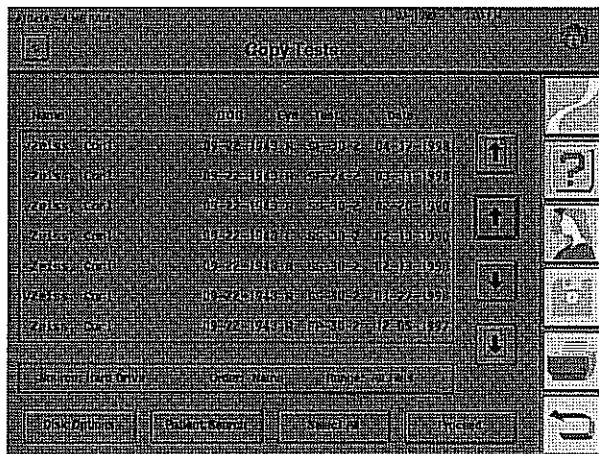

Figure 8.5: The File Directory – Sorted by Name



The page up arrow allows you to scroll one full screen at a time moving in the direction toward the top of the directory.



The single up arrow allows you to shift the list one test at a time moving in the direction toward the top of the directory.



The single down arrow allows you to shift the list one test at a time moving in the direction toward the bottom of the directory.



The page down arrow allows you to scroll one full screen at a time moving in the direction toward the bottom of the directory.



OR



OR



There are a number of buttons at the bottom of the File Directory screen which help to simplify the search for the desired patient tests.

To review or change the search criteria as designated on the Disk Options screen, select DISK OPTIONS. See "Disk Options" and Figure 8.2.

When the directory order is set to Name or Patient (alphabetical searches), PATIENT SEARCH allows you to quickly locate a specific test within the directory by entering a name on the pop-up keyboard. When the directory order is set to Date, PATIENT SEARCH is replaced with DATE SEARCH and you use the keypad to enter the desired date. In both cases, the search is limited to only those tests meeting the search criteria in Disk Options.

SELECT ALL selects and puts a check mark (✓) next to every test in the directory. The SELECT ALL button changes to SELECT NONE allowing you the opportunity to deselect all tests.

Note: Pressing SELECT ALL selects all the available tests, not just the seven (7) being viewed on the screen.

After you have selected all the tests necessary for the File Function, choose PROCEED to execute the function. A confirmation screen will always be presented noting how many tests have been selected before any action takes place.

Abbreviations used on the File Directory screen to identify tests strategies include:

- BY** Blue-Yellow
- FP** FastPac
- SF** SITA-Fast
- SS** SITA-Standard

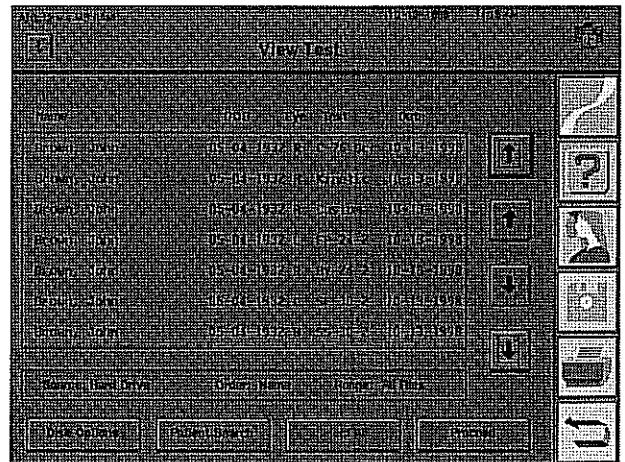

Set Current Range

The SET CURRENT RANGE feature allows you to tailor how you search for, display and print information. It is available when performing Print functions, Patient Data functions and any File Function other than DUPLICATE FLOPPY, INITIALIZE FLOPPY, or BACKUP/RESTORE.

1 After choosing one of the appropriate File Functions, the Disk Options screen will appear. Select SET CURRENT RANGE to view this screen. Use the FROM and TO buttons to specify the search range.

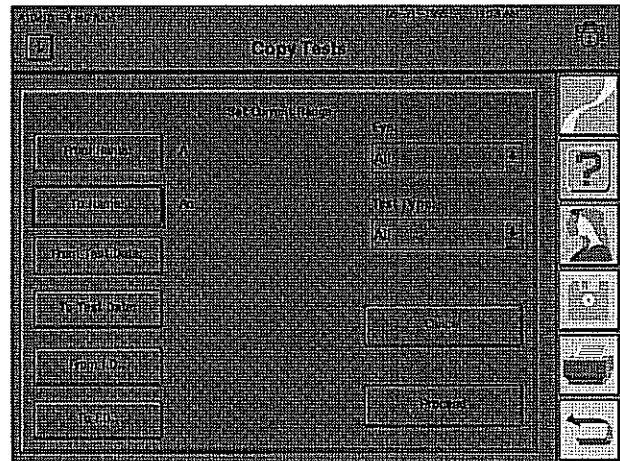

You may use the any of the 3 directory orders when using the SET CURRENT RANGE feature. File ranges may be set to one of the following:

- From Name to Name,**
- From Test Date to Test Date,**
- From ID to ID.**

The use of setting the search range is illustrated in the following example:

You have a floppy disk on which you store all tests for patients with last names starting with the letter "A". This disk is now full. To create room, you wish to move all the tests with last names starting with "A" to "Am" to a new floppy disk and leave all the tests with names starting from "An" to "Az" on the current disk. From the File Functions screen select MOVE TESTS. Next, on the Disk Options screen (see Figure 8.2), you designate the Source and Destination then press SET CURRENT RANGE.

At the Set Current Range screen (see figure above) select the FROM NAME button and enter "A". Press ENTER. Select the TO NAME button and enter "An". You select "An" instead of "Am" because the TO ranges are non-inclusive. The HEA II selects everything up to, but not including, the TO field entered. So selecting "An" means the search will stop at "Am" without including names starting with "An". Press PROCEED to access the File Selection box. Only the tests in your designated range will be available. Pressing SELECT ALL will select every test in this range.

When SET CURRENT RANGE is accessed, the following choices are also available:

EYE Choose from **All, Left or Right**

TEST TYPE Choose from **All, Threshold, Screening, Kinetic, or Custom**

If, for example, "Left" is chosen under EYE, only tests done on left eyes in the range you set will be chosen. Further, if "Threshold" is chosen under TEST TYPE, then only threshold tests in the selected range will be searched. Of course, you may select "Left" and "Threshold" at the same time if you only want to search for threshold tests performed on left eyes.

2 After the desired range(s) has been specified, press PROCEED. The HEA II will now list on the File Directory screen only the tests matching your specified range(s) until you complete or cancel the current operation.

The SET CURRENT RANGE feature is particularly useful if you are using alphabetical floppy disks and you fill a disk (as in the example above). By selecting a range of tests to copy or move to a new disk, instead of selecting individual tests, you may use the SELECT ALL button and copy or move the full range selected.

Merging patient files



MERGE PATIENTS allows you to resolve any inconsistencies in how you entered the name and date of birth for an individual patient. Slight differences in patient identification over a number of visits can cause the HEA II to treat tests taken by the same patient as tests taken by different patients. As a result, some of a patient's tests may not be included in STATPAC analysis. For example, if patient Patricia Smith is entered into the Patient Data 1 screen as "Smith, Patricia" on one visit but as "Smith, Patty" on another, the HEA II will think that two different patients took these tests.

To help avoid these differences, you should enter a returning patient's data via the RECALL PATIENT DATA button. The MERGE PATIENTS feature is available during patient data recall to help clear up extra patient entries. See Section 3: "Recalling Patient Data" for additional information.

MERGE PATIENTS may be accessed on any File Directory screen when the directory displays Patient order.

1 Select the desired test function (VIEW TEST, COPY TEST, etc.)

2 Select PATIENT from Directory Order. Press PROCEED.

3 Choose the two tests you wish to merge. A check mark will appear next to the selected tests once they have been chosen.



4 Press MERGE PATIENTS. A pop-up window will display both choices, including the date of birth and the ID number.

5 Press the button to the left of the name you wish to use as the correct test. An "X" will appear next to that patient.

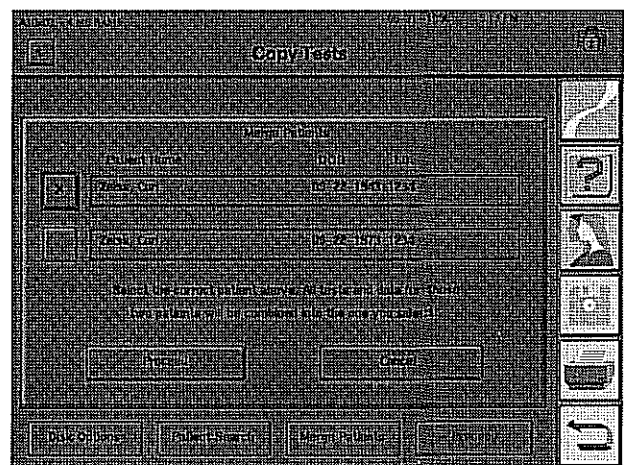

6 Press PROCEED. All the test results for the two patient entries selected will be combined into the file marked with the "X".

PERFORMING FILE FUNCTIONS

To execute most File Functions you follow a similar procedure:

- Choose the function.
- Select the Source (and Destination) of the tests.
- Select a directory order and retrieve the file directory.
- Select the test(s) from the directory for the chosen function.
- Press PROCEED and confirm your choice.

Here are step-by-step instructions for performing each File Function.

To view previously saved tests:

1. Start at the File Functions screen. Select VIEW TEST.
2. Designate the Source and Directory Order, then select PROCEED.
3. Use the keyboard to help select the test you want to view.
4. Choose PROCEED to display the test results.

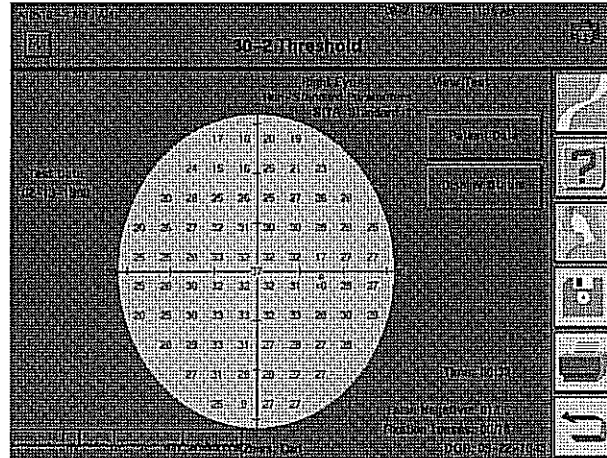

Figure 8.6: The View Test Screen

Test results can be printed by pressing the *PRINT FUNCTIONS* icon. Patient data is viewed by pressing the *PATIENT DATA* button. Patient data can also be changed for the test being viewed on the same screen. The *PATIENT DATA* icon is ghosted during the View Test operation. Test parameters in effect during the test may be seen by pressing the *DISPLAY STATUS* button.



To change patient data:

When changing patient data associated with a single test, any information contained in the Patient Data 1 or Patient Data 2 screens can be altered, including the test date (a useful feature if the internal calendar was incorrect at the time of testing). Single test data may also be changed by using View Test as described above. When changing patient data associated with all tests of a given patient, you may only alter patient name, date of birth, and ID number. Instructions to change patient data follow.

1 To change data on all of a patient's tests at one time, start at the File Functions screen. Select CHANGE PATIENT DATA, then choose ALL TESTS.

2 Select the desired Source. Press PROCEED.

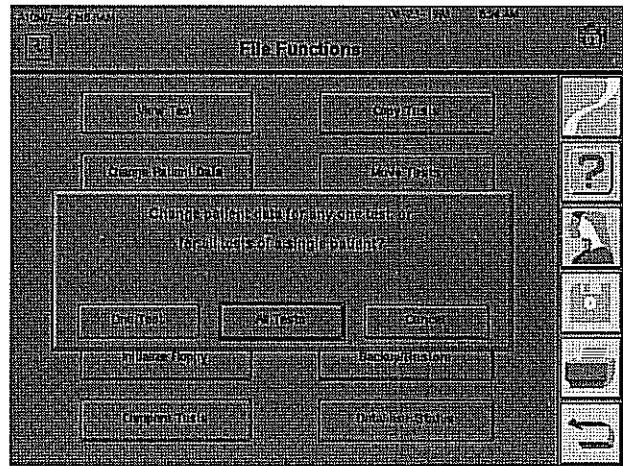

3 Use the keyboard to locate the patient. Choose the patient from the file directory screen. Press PROCEED.

You are only permitted to change name, date of birth, and ID number when ALL TESTS is selected.

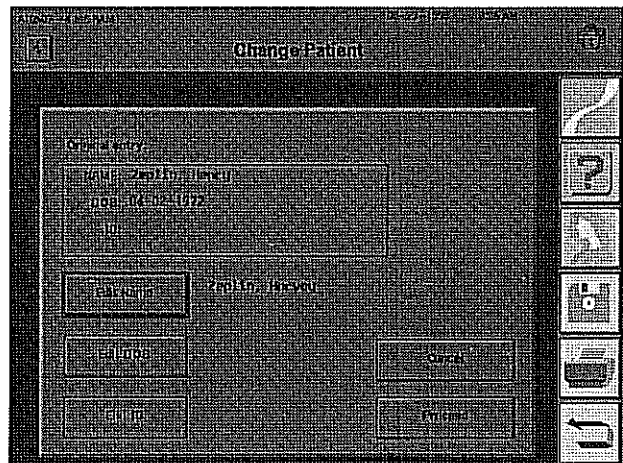

To change patient data on a single test for a given patient, select ONE TEST in Step 1. Choose the Source and the Directory Order on the Disk Options screen. Use the keyboard to locate the patient. After selecting the patient from the directory and pressing PROCEED, the Change Patient Data screen appears (see example). Add or change any data to the test, including the test date, as desired.

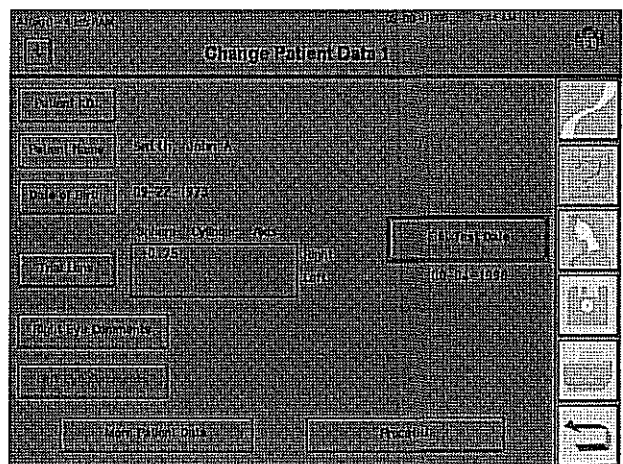



To print a file directory:

1 From the File Functions menu select PRINT DIRECTORY.

2 Select either HARD DRIVE or FLOPPY to indicate which directory you want to print. If you wish to print a partial directory of either, choose PARTIAL.

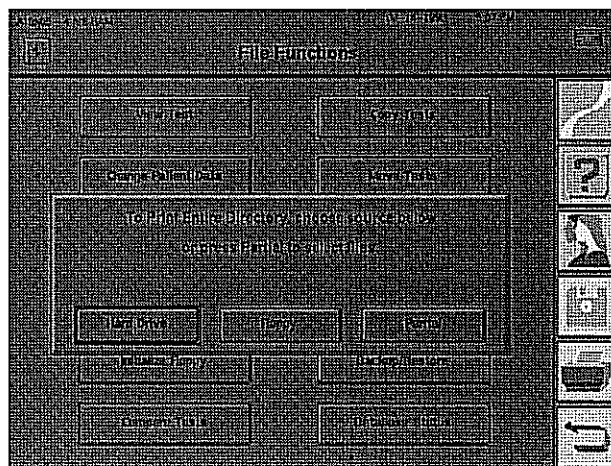

3 If you select HARD DRIVE, a message will appear telling you how many tests will be listed on the directory. Pressing YES will initiate printing the directory in Name order.

If you select FLOPPY, a directory of all tests on the floppy disk will be printed in Name order. If you select PARTIAL, you can then specify either HARD DRIVE or FLOPPY as the Source, and either Name or Date as the order. The keyboard and the file directory screen will be displayed to allow you to choose the tests to include in the partial directory. Directories cannot be printed in Patient order. To print a complete chronological (Date) directory, choose PARTIAL and the press the SELECT ALL button on the file directory screen before pressing PROCEED.

Note: You may cancel printing at any time by selecting CANCEL from the print progress pop-up window.



To duplicate floppy disks:

- 1.** Start at the File Functions screen. Select DUPLICATE FLOPPY.
- 2.** Put the Source disk (the disk you want to copy) in the floppy drive.
- 3.** Select OK to proceed or CANCEL to return to the File Functions menu. If you select OK, the next screen displays, "Reading Source Disk".
- 4.** When instructed to do so, remove the Source disk and put the Destination disk in the floppy drive. Note that this procedure will *erase* all old data from the Destination floppy disk prior to copying the information from the Source disk onto it. Press OK to proceed, or CANCEL to abort the procedure and leave the Destination floppy unchanged. If you select OK, the next screen displays, "Writing to Destination Disk". *Remember to make sure that the Destination disk has NO valuable information on it before you decide to duplicate information onto it. Everything on the Destination disk will be replaced with all of the information on the Source disk when the DUPLICATE FLOPPY function is used.*
- 5.** Remove the Destination disk when you see the confirmation message, "Floppy Successfully Duplicated". If the duplication fails, repeat Steps 1-4. If the duplication fails again, repeat Steps 1-4 with a different Destination disk. Direct problems to Humphrey Customer Service. Duplication may also be done using any IBM PC compatible computer.

Caution: Use only High Density (HD) 1.44 MB disks. Regular density (720 K) and 2.88 MB Super High Density (SHD) disks will not work with the HEA II. You risk losing data if you use anything but High Density floppy disks.

Initialize Floppy

To initialize a floppy disk:

To prepare the floppy disk for storage of HFA II data, the floppy needs to be initialized first.

1. Start at the File Functions screen. Select INITIALIZE FLOPPY.
2. Insert a floppy disk into the drive.
3. Select OK to proceed with the initialization or CANCEL to leave the floppy disk intact and return to the File Functions menu. If you select OK, the next screen displays, "Formatting in Progress". The formatting process takes approximately two (2) minutes. *Remember that the INITIALIZE FLOPPY function permanently erases ALL information currently stored on the floppy disk in the disk drive.*
4. Remove the disk when you see the confirmation message, "Floppy Successfully Formatted". If the formatting fails, repeat steps 1-3.

Caution: INITIALIZE FLOPPY prepares the disk to record information from the HFA II. All data previously stored on the disk will be erased during initialization. Duplication and initialization may also be done using any IBM PC compatible computer. Use only High Density (HD) 1.44 MB disks. Regular density (720 K) and Super High Density (2.88 MB) disks will not work with the HFA II.

Compare Tests

To compare test results:

The Compare feature analyzes the results of two threshold tests to show the change in threshold values. Negative values indicate decreased sensitivity; positive values indicate increased sensitivity.

Tests must be from the same patient, the same eye, the same test type, and must be of the same test pattern with one exception: 24-2 and 30-2 tests may be analyzed together. However, only the points the patterns share in common will be compared. Tests must also be stored on the same disk. You may print the results of a COMPARE TESTS by pressing the *PRINT FUNCTIONS* icon. Compared test results cannot be saved.

1 To compare two tests, select COMPARE TESTS from the File Functions menu.

2 Select either HARD DRIVE or FLOPPY to indicate your test source. Press PROCEED.

3 Select the two tests that you wish to compare, making sure that they are for the same patient. The order in which you choose them is not important because the calculations are based on the test dates.

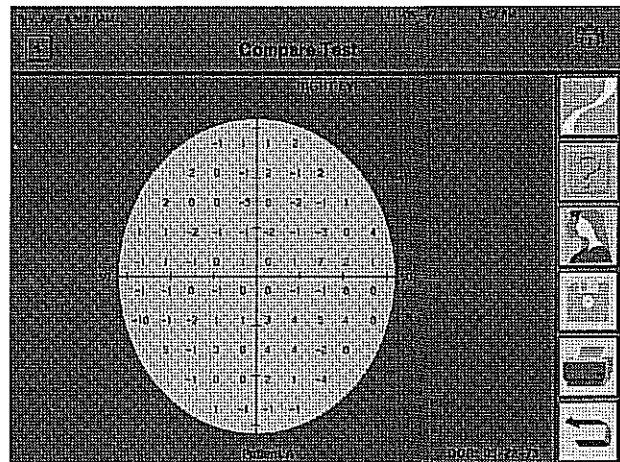

4 Press PROCEED. The Compare Test screen will appear. It features a test pattern with the change in sensitivity between the tests at each point in the visual field. As noted above, negative values indicate decreased sensitivity; positive values indicate increased sensitivity.

Copy Tests**To copy tests:**

This function copies one or more tests from one disk to another, leaving the original record unchanged.

1. Start at the File Functions screen. Select COPY TESTS.
2. Designate the Source and Destination disks and Directory Order, then PROCEED.
3. Select the test(s) you want to copy or SELECT ALL to copy all tests saved on the Source.
4. Select PROCEED to begin copying tests.
5. The selected tests will be added to the information on the Destination disk without affecting the information already stored there.

Move Tests**To move tests:**

This function moves tests to a different disk and then automatically deletes the original record from the source disk.

1. Start at the File Functions screen. Select MOVE TESTS.
2. Designate the Source and Destination disks and Directory Order, then PROCEED.
3. Select the test(s) you want to move or SELECT ALL to move all tests saved on the Source.
4. Select PROCEED to begin moving tests.
5. The selected tests will be removed from the Source and added to the Destination disk without affecting the information already stored on the Destination disk.

Delete Tests**To delete tests:**

This function deletes test records from the designated disk.

1. Start at the File Functions screen. Select DELETE TESTS.
2. Designate the Source disk and Directory Order, then PROCEED.
3. Select the test(s) you want to delete or SELECT ALL to delete all tests on the designated Source disk.
4. Select PROCEED. A pop-up window will ask, "Are you sure?" Choose YES to permanently delete the designated tests or CANCEL to return to the directory.

Caution: All tests deleted using the DELETE function are permanently erased from the disk. Once the DELETE function has begun, it can be stopped by pressing CANCEL, but tests already deleted before CANCEL was pressed are not recoverable.

Transferring tests between the HFA I and HFA II

There are two ways to transfer results between the HFA I and HFA II:

- By Serial Cable (using TRANSFER TESTS):
From the HFA I 635 or 640, approximately 1700 tests will transfer per hour.
- By optional external 5.25" floppy disk drive (using TRANSFER TESTS):
A full 5.25" HFA I floppy disk will take approximately 10 minutes to transfer.

There is only one way to transfer test results from HFA II to HFA I:

- By optional external 5.25" floppy disk drive (using the COPY TESTS function).

Note: HFA I instruments with 3.5" floppy drives can only transfer tests from HFA I to HFA II by the Serial Cable method. There is no way to transfer test data from the HFA II to an HFA I with a 3.5" floppy drive.

There are certain limitations to which tests will transfer from the HFA I to the HFA II. **A name and date of birth must be included on the original HFA I test in order to transfer it to the HFA II.** The transfer process will not warn you of improperly labeled HFA I tests or test results which are not eligible to be transferred. The following is a list of restrictions specific to the test type being transferred:

Threshold

- Fast Threshold or Master files will not transfer
- Compared, Averaged or Merged tests will not transfer
- Tests originally acquired on the HFA II

The Macula test: Only the first two threshold values at each point will be displayed and printed.

Note: The Peripheral 30/60-2 test on the HFA I is the Peripheral 60-4 on the HFA II. The test results will transfer, but the 4 points not found in the 60-4 pattern will not be included.

Screening

All screening tests will transfer from HFA I to HFA II except:

- The C-166 Screening test
- A screening test where the user selected the Central or Peripheral Reference Level
- Auto Diagnostic tests

Note: The Peripheral 68 test on the HFA I is the P-60 on the HFA II. These test results will transfer, but the 8 points not found in the P-60 pattern will not be included.

Custom

Custom Arc and Profile tests will not transfer.

Kinetic

Kinetic test results can only be transferred from the HFA I via 5.25" floppy disk (using the optional 5.25" external floppy drive). Kinetic test results cannot be transferred from the HFA II to the HFA I.

To transfer tests from the HFA I to the HFA II via serial cable



To transfer tests via serial cable:

1. Connect the HFA I and HFA II with an IBM PC compatible serial connector cable (9 pins on one end and 25 pins on the other). There are three serial ports on the back panel of the HFA II. Plug the end of the cable with nine (9) pins into serial port number 1 on the HFA II (the one next to the printer port). Plug the 25 pin connector into the serial port on the back of the HFA I. Refer to "System Components" in Section 1 of this guide for a detailed illustration of the ports on the HFA II.
2. Turn both instruments ON.

ON THE HFA II:

3. From the System Setup screen, select SAVE/TRANSMIT OPTION.
4. Select RS-232 OPTIONS.
5. On the RS-232 Options screen, set BAUD RATE to 9600, PARITY to Even, DATA BITS to 7, and STOP BITS to 1.
6. Press PROCEED. The Transmit/Save screen will then appear. Press PROCEED.
7. Press the *MAIN MENU* icon on the upper right of the screen.
8. From the Main Menu, select FILE FUNCTIONS.
9. Select TRANSFER TESTS.
10. Select HFA I SERIAL CABLE as the Source.
11. Choose HARD DRIVE or FLOPPY as the Destination, then press PROCEED.

ON THE HFA I:

12. From the Main Menu, select CONFIGURATION MENU.
13. Make sure the BAUD RATE is set to 9600 and the PARITY is set to EVEN on the Configuration Menu screen, then select RETURN (to the Main Menu).
14. Select DISK FUNCTIONS.
15. Select TRANSMIT FILES.
16. Select the disk drive on which the tests you want to transfer are stored.
17. If you want to transmit a limited number of files, highlight those files and choose SELECTION COMPLETE. If you want to transmit all the files on the HFA I disk, do not highlight any files. Just choose SELECTION COMPLETE.

ON THE HFA II:

18. A pop-up window will update the user on the progress and success of test transfer.
19. When the "tests transferred" count on the pop-up window has not changed for several seconds, test transfer is complete. Press CANCEL. If you do not press CANCEL within about 10 minutes, the HFA II will automatically proceed to the next step.
20. The transferred tests will then be moved from temporary to permanent storage. Press OK when the pop-up window informs you that the transmission is complete.

EXTERNAL 5.25" FLOPPY DISK DRIVE

(optional on all models)

An optional external 5.25" floppy drive is available from Humphrey Systems. With the external floppy drive:

1. Most test results from the HFA I may be transferred to the HFA II.
2. Most test results may be copied to larger 5.25" floppy disks for use with the HFA I.
3. Most threshold results may be copied to the larger 5.25" floppy disks for use with STATPAC for Windows.

There are certain limitations that must be understood about 5.25" floppy disks before attempting to transfer or copy data using the external 5.25" floppy drive.

1. Only double-sided, double-density (DSDD) floppy disks may be used with the external 5.25" floppy drive. These are the same disks normally used by the HFA I. Never use double-sided, high-density (DSHD) floppy disks.
2. **It is important to understand that 5.25" floppies cannot be used interchangeably between the HFA I and HFA II. The internal disk drive on the HFA I and external disk drive attached to the HFA II read and write data to the 5.25" floppy disk in a slightly different fashion. You should always label the 5.25" floppy as to which HFA (I or II) originally formatted the disk. Not observing the following guidelines will cause data to be lost.**
 - a. 5.25" floppy disks that were originally formatted by the HFA I can be read by either the HFA I or HFA II, but only the HFA I can write new test data onto these disks. HFA I floppy disks can only be re-formatted on the HFA I. **Do not attempt to write to an HFA I disk with the HFA II.**
 - b. 5.25" floppy disks that were formatted by the HFA II can be read by either the HFA I or HFA II, but only the HFA II can write new information on these disks. The HFA II can only use new 5.25" floppy disks or 5.25" floppy disks that have been bulk-erased. **Never attempt to reformat a used HFA II floppy disk. Do not attempt to write to an HFA II disk with the HFA I.**
3. When tests are going from HFA I to HFA II you always use the TRANSFER TESTS button. When tests are going from HFA II to HFA I you always use the COPY TESTS button.
4. When transferring tests from the HFA I to the HFA II, all the eligible tests on the disk will be transferred. You do not have the ability to choose which HFA I tests should be transferred. Therefore, make sure only the tests you wish to have transferred are on the HFA I 5.25" floppy disk in the external floppy drive.
5. When HFA II data is going to the HFA I, data unique to the HFA II, such as gaze tracking plots or SITA tests will not transfer. Additional test transfer limitations were listed earlier in this section.

Connecting the 5.25" external floppy drive to the HFA II

Turn off your instrument and connect the external floppy drive (see Figure 8.7 below). Attach the gender changer to the external drive interface cable and plug into the HFA II slot marked "External Floppy" (refer to "System Components" in Section 1 of this guide for further information regarding the location of this slot). Make sure that the external floppy drive power cable is plugged-in. Turn your HFA II back on.

Caution: Never leave the external drive cable plugged into the back of the HFA II without the external disk drive's power cord also plugged in. This may cause the HFA II to confuse the internal and external floppy drives, and permanent loss of information may result for both the floppy disk and the hard drive.

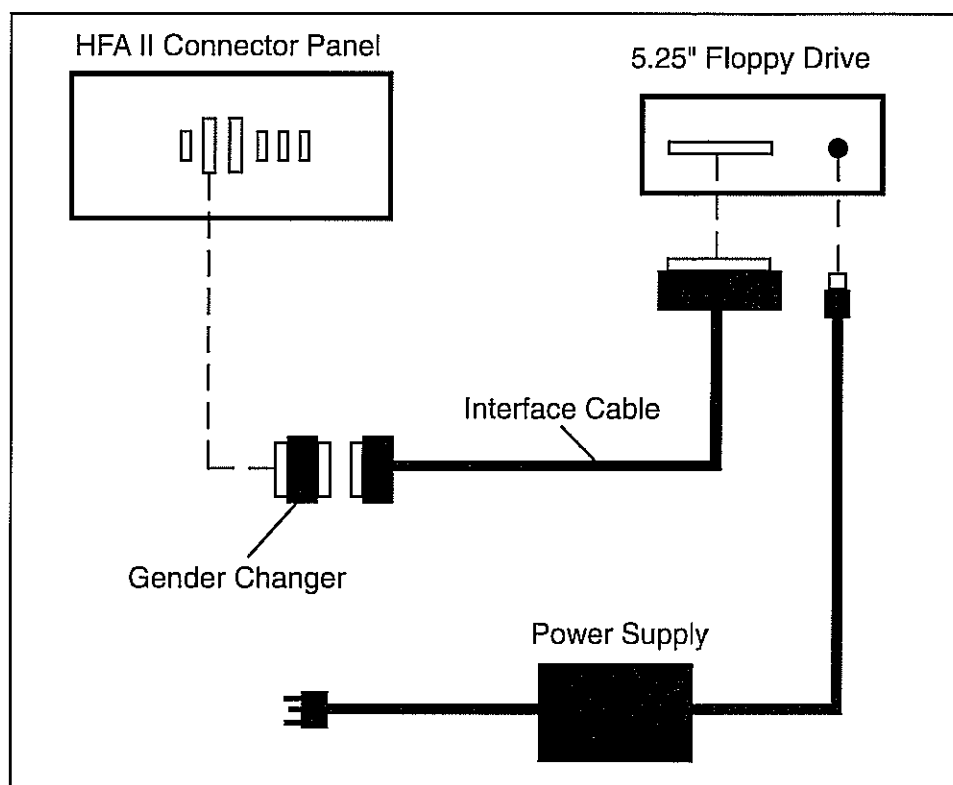

Figure 8.7: Connecting the 5.25" Floppy Drive to the HFA II.

To transfer tests from the HFA I to the HFA II via the external 5.25" floppy drive



The HFA II can transfer tests from HFA I 5.25" floppy disks to HFA II floppy disks or the hard disk. When performing this function, the HFA II transfers every eligible test from the HFA I disk. Therefore, it is important to make sure that only tests you want to transfer are on the HFA I disk you are transferring from.

ON THE HFA I

1. If you wish to transfer only certain tests from the HFA I to the HFA II, format a new 5.25" floppy disk on the HFA I and save the tests to be transferred on this disk.

ON THE HFA II

2. Insert the HFA I 5.25" floppy disk that contains the tests you want to transfer to the HFA II into the external 5.25" floppy drive.
3. From the File Functions menu, select TRANSFER TESTS.
4. Select HFA I EXTERNAL FLOPPY as the Source and HARD DRIVE or FLOPPY DISK as the Destination.
5. Select PROCEED. All eligible tests on the HFA I disk will be transferred to the Destination disk and saved as HFA II tests. You will not be informed as to which tests do not transfer. Refer to the introduction to "Transferring Tests Between the HFA I and HFA II" for additional information.

ON THE HFA II

1. Insert either a new, unformatted 5.25" DSDD floppy disk or a floppy that has been previously formatted only by the HFA II into the external floppy drive.
2. From the File Functions screen on the HFA II, select COPY TESTS.
3. Select the appropriate Source and HFA I EXTERNAL FLOPPY as the Destination. Press PROCEED.
4. Select the tests to be copied, then select PROCEED.
5. A pop-up window will confirm that the number of tests to copy is correct. Press YES if the appropriate tests were selected.
6. If the floppy has not yet been formatted, press FORMAT when prompted. The HFA II will copy the tests to the floppy automatically after formatting the disk. Be sure to label this new floppy as an HFA II 5.25" floppy disk. If the disk was previously formatted by an HFA II, copying will proceed normally.

Caution: Be careful not to accidentally format a 5.25" floppy which contains data. Formatting the floppy permanently erases all previously stored data.

ON THE HFA I

7. Upon completion of the COPY function on the HFA II, insert the floppy disk into the HFA I floppy drive.
8. Select DISK FUNCTIONS from the Main Menu.
9. Select COPY FROM FLOPPY TO HARD DRIVE or COPY FROM FLOPPY TO FLOPPY, then select PROCEED.

To copy tests from the HFA II to the HFA I via the external 5.25" floppy drive



Database Status

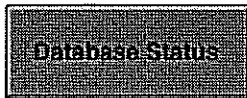

By pressing DATABASE STATUS you get information on the number of tests and the number of patients found on the hard disk and floppy disk databases. If no floppy disk is in the disk drive, "No Disk" will be displayed indicating the information is unavailable. Should the HFA II be unable to access the hard drive, "NA" will be displayed. If you back up your hard disk to floppy disks (see Section 9) and insert a backup floppy disk, the Database Status feature will recognize the floppy and indicate "Backup". Under Hard Drive on models 720 and 730, "No HD" will be seen.

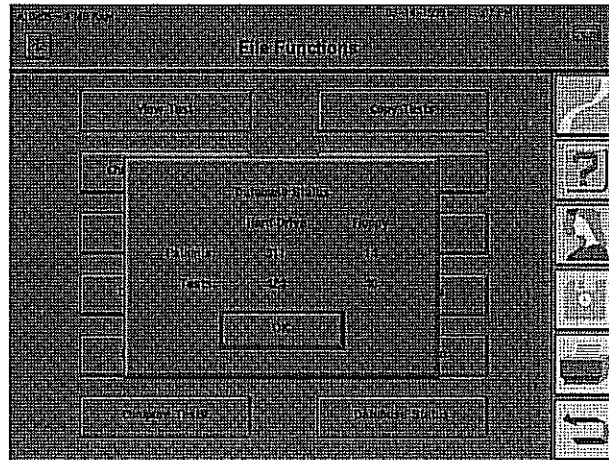

Please note that when patient information has been entered but not saved with test results, the Database Status pop-up window may give a false sense of the true number of patients with tests in the database. See Section 9: "Cleanup Hard Disk Database" for additional information.

ORGANIZING PATIENT FILES

Just as you organize patient tests that are on paper, it is also necessary to organize visual field tests on floppy disks. The system chosen depends upon the quantity of patients to be tested. Keep in mind that each floppy holds 100 to 500 tests, depending on test type. Clearly label every disk and/or streamer tape in your test library.

MODELS 720 AND 730 OWNERS

1. A set of floppy disks should be kept based on patient name according to the alphabet. For example, keep all patients with last names beginning with "A" on the same disk, those with "B" last names on another, and so on. Another approach is to designate one disk for multiple letters. For example, all patients with last names beginning with "A through D", and so on. Frequently seen patients may be given their own personal disk, which may be kept in their chart. Clearly label every disk in your file library.
2. Keep a separate chronological file of all tests. This is done by keeping an additional floppy disk with the HFA II at all times. Save all tests on this disk as well as on the appropriate alphabetical disk. When the chronological disk fills up, label it with the dates it covers and store it in a safe place. You will then have a chronological set of floppy disks from which any patient disk may be reconstructed, if necessary.
3. Retrieve the appropriate floppy disk from your file library before starting each visual field test.
4. Always print a hard copy of test results for all tests not saved to disk.
5. Periodically make copies of alphabetical and individual patient disks.

MODELS 735-750 OWNERS

1. Keep a floppy disk in the drive at all times in order to maintain a chronological copy of all tests. Each time you press SAVE ON DISK, the results will be stored on both the hard disk and floppy disk.
2. Organize floppy disks chronologically by leaving the same floppy disk in the drive until it is full and then replacing it with a new, initialized disk. Clearly label every disk in your file library with the starting and ending dates contained on that floppy.
3. Always print a hard copy of test results for all tests not saved to disk.
4. Periodically make copies of the floppy disks to protect the data.

Note: It is recommended that you store a copy of your HFA II database outside of the office to protect your data from unforeseen damage.

Be sure to read the next section: "Database Management" for more information on the importance of maintaining good data backup techniques.

Introduction to Database Management	9-2
Patient Database Protection Procedures	9-3
Configuration Backup and Restore	9-8
How to Handle Database Failures	9-13
Merge Database	9-23
Cleanup Hard Disk Database	9-24
Practices with Multiple Humphrey Field Analyzers	9-25
Care and Handling of Removable Storage Media	9-25

The Humphrey Field Analyzer II is like a computer in many respects. Its hard drive can “crash” and its floppy disk can “get corrupted”. Because visual field test results represent an important part of your patient’s ophthalmic history, it is imperative that you take steps to safeguard the

integrity of the data by creating backup copies of all tests. In addition to patient data, you can protect Custom test patterns, Main Menu button definitions, and System Setup selections against loss in the event of a hard disk failure. Maintaining up-to-date backup copies of your patient database is insurance against loss.



After reading this section you will be familiar with:

- recommended backup techniques
- how to backup and restore menu configurations
- how to deal with database failures
- how to keep a similar database on multiple HFA IIs
- proper handling of streamer tapes and floppy disks

Caution: Never turn off the HFA II while the hard drive or floppy disk drive is running. This may cause permanent loss of valuable data.

INTRODUCTION TO DATABASE MANAGEMENT

Database errors are inevitable. Power surges, temperature changes, and mechanical failure can disrupt the proper operation of storage devices, and prevent you from successfully saving or retrieving data. Because both hard and floppy disks store information magnetically, the information can be damaged by static electricity and strong magnets.

Database management is not difficult and should not consume much time. **Humphrey Systems strongly recommends that all HFA customers make extra copies of their patient database and setup configurations. In the event of a database problem, and you need to restore your database, you will have the solution at hand.**

For the sake of simplicity, this manual separates database management into two categories: functions which *manipulate data* (Copy Tests, Delete Tests, and Change Patient Data, for example), and functions which *preserve database integrity* (Backup Configuration, Rebuild Hard Disk Database, etc.). This section discusses preserving database integrity. All other database management functions are explained in Section 8: "File Functions".

Database integrity functions



Functions associated with preserving database integrity can be found on both the File Functions and Additional Setup Menus. These functions are outlined below.

On File Functions Menu

Duplicate Floppy
Creates an exact copy of a floppy disk; used for duplicating patient database information onto additional floppy disks.

Backup: Copies patient files from the hard disk to streamer tape or floppy disk.

Restore: Copies patient files from a streamer tape or a set of floppy disks to the hard drive. Used in the event of a hard disk failure. **The Source and Destination you choose determines whether you are backing up or restoring data.**

Database Status
Provides information on the number of tests and the number of patients found on the hard drive and floppy disk databases. It can also identify a backup floppy disk (see Section 8).

On Additional Setup Menu

Backup Configuration
Copies Custom Test Patterns, Main Menu button definitions, and System Setup selections to a floppy disk.

Restore Configuration
Reinstates Custom Test Patterns, Main Menu button definitions, and System Setup selections.

Rebuild Hard Disk Database
A database repair utility; used only in the event of hard disk database problems.

Rebuild Floppy Disk Database
A database repair utility; used only in the event of floppy disk database problems.

Clean Hard Disk Database
Deletes files containing patient data with no associated test data.

PATIENT DATABASE PROTECTION PROCEDURES

Creating alternate copies of your patient database is important, but can be a lengthy procedure. Therefore, Humphrey recommends that you choose a schedule that suits your office, preferably one that does not interfere with patient care and testing. Whether you perform 25 visual field tests each week or five, every test worth saving (whether to floppy disk, hard disk, or both) is worthy of being protected by being maintained on alternate storage media. In the event of database failure, alternate copies of your database can be used as a backup measure to minimize or eliminate data loss.

The storage media used with the HFA II, floppy disk and streamer tape, are not indestructible. Improper care and handling will affect the contents and render the media unusable. Floppy disks and streamer tapes also have a limited shelf life and should not be used indefinitely. It is advisable to rotate between at least two sets of storage media. Information on the proper care and handling of storage media is covered at the end of this section, as well as in Section 12.

Note: The following backup procedure is only one suggestion. Amend it to suit your schedule.

Model 720 and 730 database protection

Model 720 and 730 owners rely on floppy disks as their sole means of storing patient and test data; other models have an internal hard disk drive in addition to the floppy drive. As a safety measure, it is imperative that you make duplicate copies of your patient disks. This applies whether you store patient files chronologically or alphabetically.

The recommended database protection procedure for models 720 and 730 involves the following two steps:

1. Keep a floppy disk in the floppy drive at all times to capture saved data. On a weekly basis, make duplicate copies of the disks using the DUPLICATE FLOPPY file function.
2. Store floppy disks in a safe place away from the instrument.

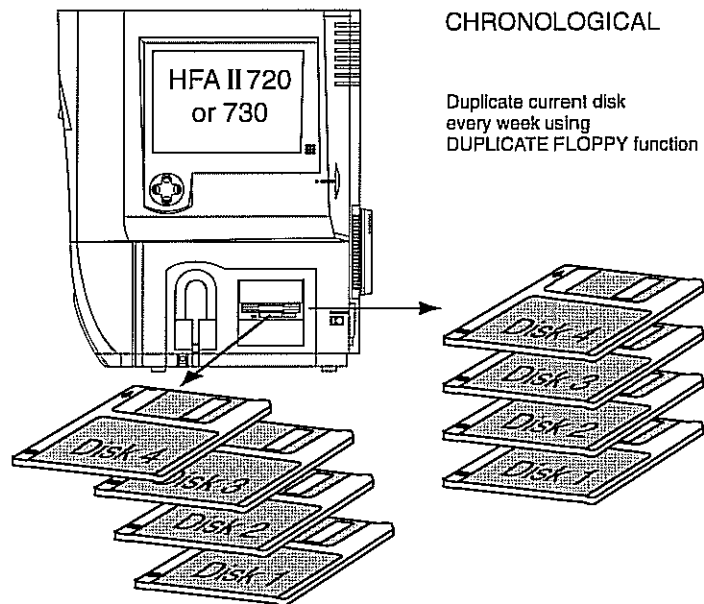

Figure 9.1: Maintaining Duplicate Chronological Floppy Disks on Models 720 and 730.

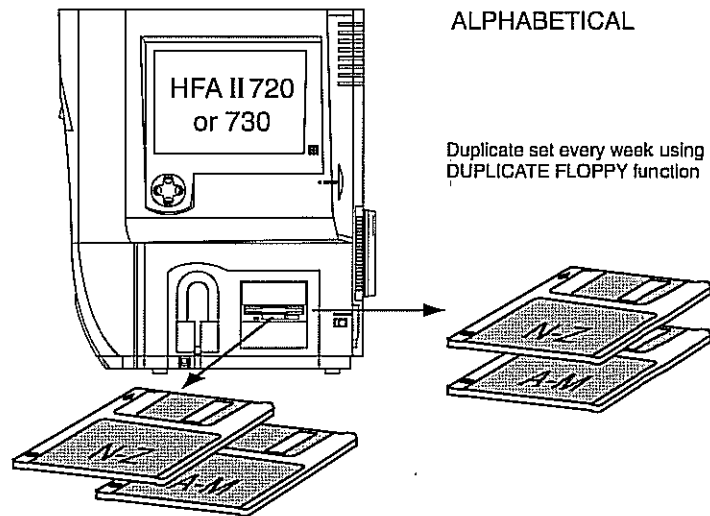

Figure 9.2: Maintaining Duplicate Alphabetical Floppy Disks on Models 720 and 730.

To duplicate a floppy disk

1. From the File Functions screen, select DUPLICATE FLOPPY.
2. Insert the Source disk in the drive and select OK.
3. When prompted, insert the Destination disk in the floppy drive and select OK.
4. When completed, remove the floppy disk, label it, and store it in a safe place.

Caution: All data on the Destination disk will be permanently erased and replaced with the information you are duplicating.

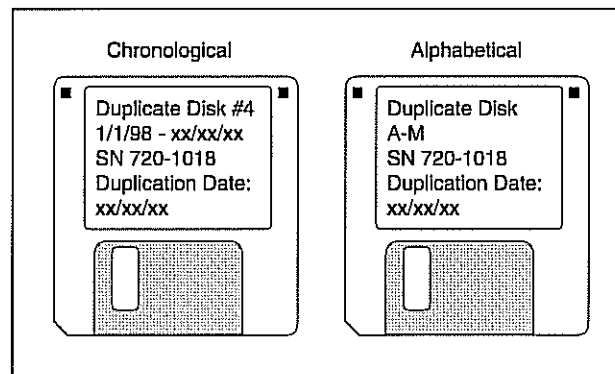

Figure 9.3: Duplicate Floppy Disks with Labels

Model 735, 740, 745
database protection

Models 735, 740, and 745 are equipped with a hard disk drive as well as a floppy drive. Every time you save a test to the hard disk, you automatically save it to a floppy disk, provided a floppy disk is in the drive. Humphrey Systems recommends that you keep a disk in the floppy drive at all times. This safety precaution ensures that you will have at least one copy of every test that is on the hard drive. Maintaining this one copy of your database is not sufficient, however.

The recommended database protection procedure for models 735, 740 and 745 involves the following three steps:

1. Keep a floppy disk in the drive at all times to capture saved data. On a weekly basis, make a duplicate copy of the disk using the DUPLICATE FLOPPY file function, as described above in the section for model 720 and model 730 owners.
2. On a biweekly basis (every other week), create a "backup" set; use the BACKUP utility to copy the entire hard drive database onto a special set of floppy disks (this usually requires multiple floppy disks, or a series of disks).
3. Store duplicate disks in a safe location away from the instrument.

Why do both? In the event of a hard disk failure, you may need to restore your database from floppy disks. The likely first choice is to use the backup set of floppy disks (#2 above); that would be the quicker solution of the two. The one caveat, or weakness, in this decision, is that the backup set of floppy disks acts as a unit. In other words, should one disk in the series be flawed, the entire set becomes unusable. If this were to occur, you would use your duplicate disks as created in number 1 above, and copy the files to the hard drive. This is a good alternative, though a far slower one.

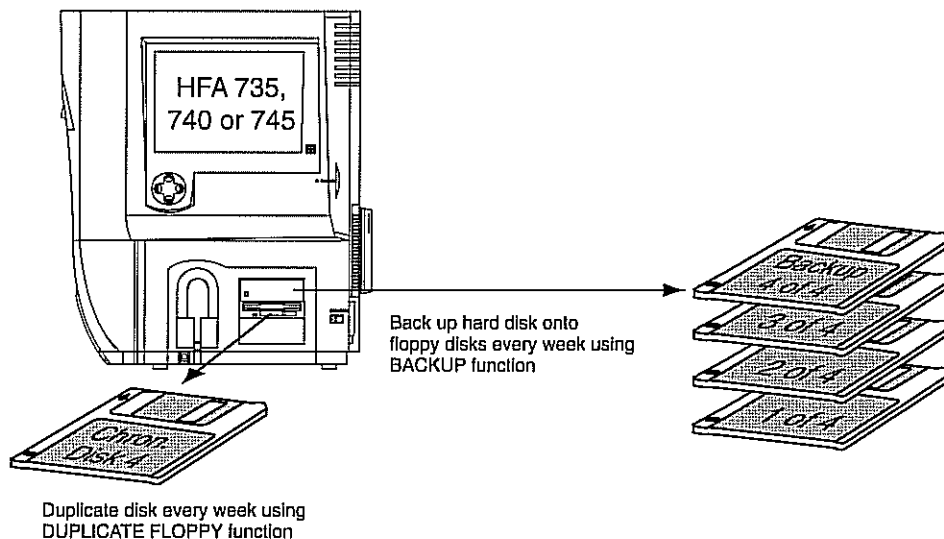

Figure 9.4: Maintaining Backup Floppy Disks on Models 735, 740 and 745

To back up hard drive data onto floppy disks (model 735, 740, 745)

1. From the File Functions screen, select BACKUP/RESTORE.
2. Choose HARD DRIVE as the Source.
3. Choose FLOPPY as the Destination.
4. Select PROCEED.
5. Insert the first floppy and select OK..
6. Insert each additional floppy disk when instructed.
7. Label the floppy disks as shown in Figure 9.5.
8. Store the floppy disks in a safe location.

Caution: Though the HFA allows you to back up the entire contents of your hard drive to floppy disk (BACKUP to FLOPPY), Humphrey Systems does not recommend that you adopt this as your sole backup procedure. If, while restoring data, one floppy disk in the series is damaged, the entire set becomes unusable.

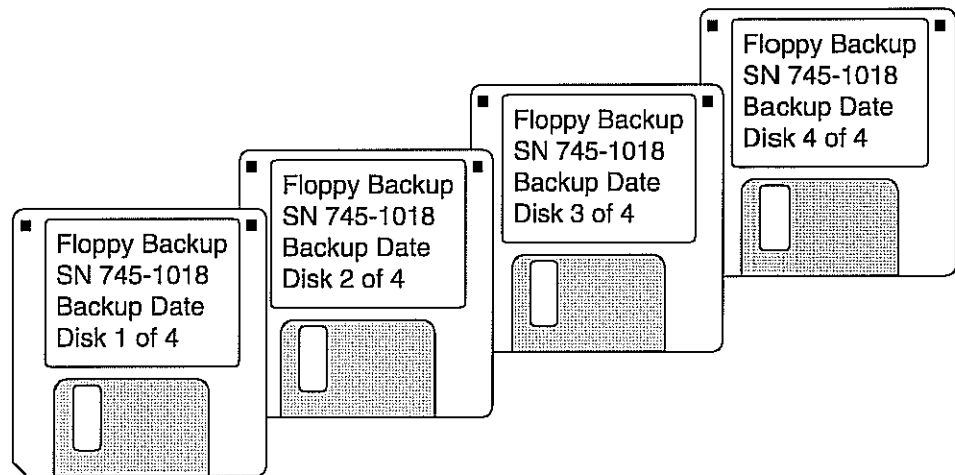

Figure 9.5: Set of Backup Floppy Disks with Labels